

# HP Jornada 520 Series Pocket PC

## User's Guide



Printed in Singapore  
Edition 1

---

# Copyright

The information contained in this document is provided “as is” and is subject to change without notice.

Hewlett-Packard Company makes no warranty of any kind with regard to this manual, including, but not limited to, the implied warranties of merchantability and fitness for a particular purpose. Hewlett-Packard Co. shall not be liable for any errors contained herein or for incidental or consequential damages in connection with the furnishing, performance, or use of this manual or the examples herein.

© Hewlett-Packard Co. 2001.

This document contains proprietary information that is protected by copyright. All rights are reserved. No part of this document may be photocopied, reproduced, adapted, or translated to another language without the prior written consent of Hewlett-Packard Co., except as allowed under the copyright laws.

The programs that control this product are copyrighted and all rights are reserved. Reproduction, adaptation, or translation of those programs without prior written permission of Hewlett-Packard Co. is also prohibited.

Microsoft, ActiveSync, Outlook, Pocket Outlook, Expedia, AutoRoute Express, MapPoint, Windows, Windows NT, the Windows logo, and the Windows CE logo are either registered trademarks or trademarks of Microsoft Corporation in the United States and/or other countries. Microsoft products are licensed to OEMs by Microsoft Licensing, Inc., a wholly owned subsidiary of Microsoft Corporation.

All other brand names and product names used in this document are trade names, service marks, trademarks, or registered trademarks of their respective owners.

Hewlett-Packard Singapore (Pte) Ltd.  
Asia Pacific Personal Computer Division  
452 Alexandra Road  
Singapore 119961

---

# Contents

1   Welcome .....	1
What's in the box .....	2
Using this manual .....	2
What's on your HP Jornada .....	4
Where to find information.....	7
2   Getting started.....	9
Hardware features .....	10
Using your HP Jornada for the first time .....	12
Turning your HP Jornada on and off.....	14
Using the hardware buttons and LED .....	14
Navigating in Windows for Pocket PC .....	16
Entering information.....	20
Finding and organizing information .....	27
3   Connecting to your desktop PC.....	29
Installing Microsoft ActiveSync on your desktop PC .....	30
Installing the HP Dynamic Voice audio codec.....	31
Connecting your HP Jornada.....	33
Establishing a partnership.....	36
Synchronizing data .....	37
Browsing your HP Jornada from your desktop.....	39
Transferring files between your HP Jornada and your desktop PC.....	40
Backing up and restoring data .....	40
4   Connecting to the Internet or to a network.....	45
Connecting your HP Jornada.....	46
Creating an ISP or network connection .....	48
Browsing the Web (or a corporate intranet) .....	50
Sending and receiving e-mail.....	55
5   Configuring your HP Jornada .....	61
Managing power .....	62
Managing memory .....	63
Adjusting settings.....	64
Security.....	66
Configuring hardware buttons.....	68
Configuring menus.....	70
Adding or removing programs.....	72

---

6   Microsoft Pocket Outlook.....	75
Calendar: scheduling appointments and meetings .....	76
Contacts: tracking friends and colleagues .....	77
Tasks: keeping a to-do list .....	79
Notes: capturing thoughts and ideas .....	80
Exchanging appointments, contacts, tasks, and notes with other devices (HP info exchange) .....	81
7   Companion programs .....	83
Microsoft Pocket Word.....	84
Microsoft Pocket Excel.....	85
Microsoft Windows Media Player .....	86
Microsoft Reader .....	89
OmniSolve .....	90
8   Accessories .....	91
HP branded accessories.....	92
CompactFlash cards.....	93
9   Troubleshooting.....	95
Resetting your HP Jornada.....	96
Basic problems .....	98
Remote connections .....	101
Display problems .....	103
10   Support and service.....	105
Web site.....	105
Customer support .....	105
Service.....	105
Contacting Hewlett-Packard worldwide.....	106
Warranty.....	109
Glossary .....	115
Appendix A: Character recognition.....	119
Appendix B: Migrating data from other devices .....	123
Index .....	127

---

# 1 | Welcome

Congratulations on purchasing the Hewlett-Packard Jornada 520 Series Pocket PC, a Microsoft® Windows®-powered Pocket PC. Your HP Jornada Pocket PC lets you keep your most important business and personal information current and close at hand. Your HP Jornada includes the Microsoft Windows for Pocket PC software, such as the latest version of Microsoft Pocket Outlook®, so you can read and write e-mail while on the road and manage your appointments and contacts. You will find that your HP Jornada is also the perfect companion to your desktop or notebook PC, allowing you to take vital business data and documents with you and easily upload updated information upon returning to your desk. HP Jornada offers you the highest quality in performance and power management as well as rich programs and utilities designed by Hewlett-Packard, making HP Jornada your powerful, reliable, mobile business partner.

In this chapter, you will find:

- a list of the HP Jornada package contents
  - an overview of this User's Guide, and pointers to other sources of helpful information
  - descriptions of the programs and features included with your Pocket PC
-

## What's in the box

Your HP Jornada package includes the following items:

- HP Jornada Pocket PC, with carrying pouch and stylus
- ac adapter
- serial cable for connection to a desktop PC
- HP Jornada Quick Start Guide—a graphic guide to setting up your HP Jornada
- HP Jornada CD-ROM—includes programs and utilities that add functionality to your HP Jornada; this User's Guide, which provides detailed information about your HP Jornada hardware and software; and the HP Jornada Accessories Guide, which provides information about optional add-ons to your HP Jornada.
- HP documentation pack—includes the Regulatory Information Leaflet and the HP Jornada Accessory Guide
- Microsoft ActiveSync® CD-ROM and *Getting Started with Microsoft ActiveSync* booklet

## Using this manual

This User's Guide is designed to help you get started using your HP Jornada quickly and easily. Although great care has been taken to ensure the accuracy of procedures and artwork, some of the screens displayed on your HP Jornada may be different than the ones that appear in this User's Guide.

Detailed, step-by-step instructions for using the programs on your HP Jornada are also included in online Help, so you will always have access to them, and you do not have to carry this guide when you travel. (For more information on using online Help, see "Using online Help on your HP Jornada" later in this chapter.)

This User's Guide includes the following chapters:

- **Chapter 1, Welcome.** Offers a quick overview of the HP Jornada package and this User's Guide.
  - **Chapter 2, Getting started.** Provides step-by-step instructions for charging your Pocket PC, completing the Welcome Wizard, and preparing to use your HP Jornada for the first time.
  - **Chapter 3, Connecting to your desktop PC.** Offers everything you need to know to connect your Pocket PC, transfer files, and synchronize Microsoft Pocket Outlook data and e-mail messages.
-

- **Chapter 4, Connecting to the Internet or to a network.** Explains how to use a CompactFlash card modem\* to connect to the Internet through an Internet service provider, or install a CompactFlash network interface card to connect to a network. Once you are online, you can browse the Internet or intranet, and send and receive e-mail directly from your Pocket PC.
- **Chapter 5, Configuring your HP Jornada.** Details the many ways you can add functionality to your HP Jornada by installing additional software and programs, and explains how you can customize your HP Jornada using HP settings and control panels.
- **Chapter 6, Microsoft Pocket Outlook.** Describes the Contacts, Calendar, Tasks, and Notes programs (“personal information manager” programs) included with your HP Jornada.
- **Chapter 7, Companion programs.** Describes the productivity programs included with your HP Jornada, including the Microsoft Windows for Pocket PC software (Microsoft Pocket Word, Pocket Excel, Microsoft Reader, and the Windows Media™ Player), and the OmniSolve® calculator from Landware.
- **Chapter 8, Accessories.** Describes the HP accessories available for your Pocket PC, and includes instructions on how to add functionality using a CompactFlash card.
- **Chapter 9, Troubleshooting.** Explains how to reset your Pocket PC and how to restore your Pocket PC to the factory default settings, and provides helpful tips and procedures to follow when things do not work quite as you expected.
- **Chapter 10, Support and service.** Includes phone numbers and directions to help you obtain technical support from Hewlett-Packard.

This User's Guide includes certain visual cues that will help you find the information you want easily.



A shortcut, another way to do something, or expanded information about the topic.



Caution or warning information about the topic. This is important information that should be observed to prevent loss of data or damage to your HP Jornada.



Helpful information related to the topic.

---

\* Modem must be purchased separately. Some Web sites/content may not be available.

---

## What's on your HP Jornada

Your HP Jornada already includes the full suite of software you need to function as a mobile professional. These programs are introduced below. Detailed information can be found in later chapters.

---



The programs listed below are installed in ROM. They cannot be deleted, and you will never need to reinstall them.

---

### HP programs



**HP settings.** Adjust the brightness and contrast of the display and set the speaker volume to suit your work environment. Choose from four preset profiles or create your own.



**HP security.** Protect your data with a four-digit password that prevents unauthorized users from accessing your HP Jornada.



**HP backup.** Protect your valuable data even when you are away from your office by backing up your personal information manager (PIM) databases (Contacts, Calendar, and Tasks) or your entire Pocket PC to a CompactFlash card.



**HP game buttons.** Run up the score in your favorite games on your Pocket PC. Use the HP game buttons application to assign game actions to your Pocket PC hardware buttons.



**HP home menu.** Quickly launch your favorite programs or open frequently used documents. Assign each of the buttons on the HP home menu to a different document or program.



**HP task switcher.** Switch between open programs and documents, or close any program from a pop-up menu on the Today screen.



**HP info exchange.** Send and receive contacts, appointments, and tasks to and from non-Windows-powered devices from within Pocket Outlook. Also receive (but not send) notes and store them as a text file in the My Documents folder of your HP Jornada.

---



## Microsoft Windows for Pocket PC software

**Calendar.** Keep track of your appointments and create meeting requests.



**Contacts.** Keep track of your friends and colleagues.



**Inbox.** Send and receive e-mail messages.



**Notes.** Create handwritten or typed notes, drawings, and recordings.



**Pocket Excel.** Create new workbooks, or view and edit Excel workbooks created on your desktop PC.



**Pocket Word.** Create new documents, or view and edit Word documents created on your desktop PC.



**Tasks.** Keep track of your tasks.



**Microsoft Pocket Internet Explorer.** Browse the Web and view channels and subscription content.



**Microsoft Windows Media Player for Pocket PC.** Play songs and sound clips on your Pocket PC. Windows Media Player lets you play songs or files that have been recorded in MP3, WMA, or WAV format.



**Microsoft Reader.** Read electronic books on your HP Jornada.



## Third-party software

**OmniSolve.** Perform complex mathematical and business calculations with this full-featured calculator from Landware.



## Additional programs

The CD-ROMs included with your HP Jornada include additional programs you can install. For installation instructions, see “Adding or removing programs” in chapter 5.

---

You can also install programs from a variety of sources, including the Internet. For more information, see “Adding or removing programs” in chapter 5.

---



Find the following programs on the HP Jornada CD-ROM:

- HP Jornada User's Guide. The User's Guide provides detailed information about your HP Jornada hardware and software. The User's Guide is provided in Portable Document Format (PDF), and requires the Adobe® Acrobat® Reader, available from the Adobe Web site at [www.adobe.com](http://www.adobe.com).
- Yahoo!® Messenger\* from Yahoo! Inc. Yahoo! Messenger allows you to instantly communicate with all your online friends, and check stock-prices, news, sports scores, and more.
- AudiblePlayer™ 2.0 for Windows CE and AudibleManager™ 3.0 from Audible Inc.\* Listen to best-selling audiobooks, newspapers, magazines, and more.
- MusicMatch® Jukebox 6.0 from MusicMatch Corporation. MusicMatch Jukebox 6.0, with new Internet Radio, gives music fans the power to play, record, organize, and discover new music. MusicMatch Jukebox and HP Jornada Pocket PC—the ultimate personal music system!
- EzWAP from EZOS. This browser enables you to browse Internet sites that use wireless access protocol (WAP) to deliver content designed specifically for mobile devices.
- Sample MP3 songs from EMusic.com™.\* EMusic.com is the premier site for your MP3 music. Whether you are into rock, jazz, blues, techno, or hip hop, EMusic.com features thousands of tracks from the artists you are looking for.
- HPC Notes™ 3.05 Lite Edition (full) and Professional Edition (trial) from PhatWare™ Corporation.\* HPC Notes 3.05 is a powerful notes creator and organizer for Windows for Pocket PC. It allows users to create notes, password-protect them, and organize them by type, subject, and creation and modification date.



The programs included on the CD-ROMs are subject to change. Check your CD-ROM for the complete list, and visit the HP Web site at [www.hp.com/jornada/solutions](http://www.hp.com/jornada/solutions) for even more programs and software updates.

---

Find the following programs on the ActiveSync CD-ROM:

- Microsoft Transcriber version 1.1 for Windows CE. Transcriber lets you take down phone numbers, notes, and more as easily and naturally as writing on a piece of paper. Transcriber recognizes all handwriting, whether cursive, printed, or a combination of both.

---

\* Available on English language versions only.

---

- Microsoft Money for Pocket PC. Record expenses, balance your checkbook, and track your investments. You can also update Microsoft Money accounts on your desktop PC with information from your HP Jornada. (Microsoft Money for Pocket PC can synchronize only with the US English version of Microsoft Money.)
- Microsoft Internet Explorer 5. Browse the Web with the latest version of the Microsoft browser software for your desktop PC.
- Microsoft Outlook 2000. Manage your messages, appointments, contacts, and tasks on your desktop PC.
- Microsoft Windows Media Manager for Pocket PC. Convert different music and sound files to the proper format and transfer them to your HP Jornada.
- Sample content for use with Microsoft Reader.

## Where to find information

The following table is a guide to additional information to help you use your HP Jornada.

For information on:	See this source:
Programs on your HP Jornada	This User's Guide or online Help on your device. Tap <b>Help</b> on the <b>Start</b> menu to view Help for the active program.
Additional programs that can be installed on your HP Jornada	The HP Jornada CD-ROM, the Extras folder on the ActiveSync CD-ROM, and the HP Web site at <a href="http://www.hp.com/jornada/solutions">www.hp.com/jornada/solutions</a> .
Connecting to and synchronizing with a desktop PC	The <i>Getting Started with Microsoft ActiveSync</i> booklet or ActiveSync Help on your desktop PC. For more details and the latest updates, visit the Microsoft Web site at <a href="http://www.pocketpc.com">www.pocketpc.com</a> .
Last-minute updates and detailed technical information	The Readme files in the Microsoft ActiveSync folder on your desktop PC and CD-ROM, and the HP Jornada Web site at <a href="http://www.hp.com/jornada">www.hp.com/jornada</a> .

---

For information on:	See this source:
Troubleshooting connections	Chapter 9 of this User's Guide or the ActiveSync Troubleshooter on your desktop PC. On the ActiveSync <b>File</b> menu, click <b>Connection Settings</b> , and then click <b>Help</b> . For more help, visit the Microsoft Web site at <a href="http://www.pocketpc.com">www.pocketpc.com</a> .
The latest on Windows–powered Pocket PCs	The Microsoft Windows for Pocket PC Web site at <a href="http://www.pocketpc.com">www.pocketpc.com</a> .



The complete text of this User's Guide is also available on the HP Web site at [www.hp.com/jornada/products/product\\_tour](http://www.hp.com/jornada/products/product_tour). You can download the User's Guide to your desktop PC and view it using the Adobe Acrobat Reader, available from the Adobe Web site at [www.adobe.com](http://www.adobe.com).

## Using online Help on your HP Jornada

You can get help for specific programs and for Windows for Pocket PC by tapping **Help** on the **Start** menu. Help is displayed for the active program. To display a menu of all Help files available on your Pocket PC, tap the **View** menu, and then tap **All Installed Help**, or simply tap **Help** while the Today screen is active.

Navigate in Help just as you navigate in Microsoft Internet Explorer: by tapping links or tapping the Back button. When you have finished viewing Help, tap  to return to the program you were using.

## 2 | Getting started

This chapter will help you start using your HP Jornada Pocket PC. You will become familiar with the hardware, learn how to set up your HP Jornada, and find a brief introduction to the Windows for Pocket PC operating system. When you finish this chapter, you will have all the information you need to begin working with your HP Jornada.

This chapter includes step-by-step instructions to help you

- Identify hardware features.
  - Complete the Welcome Wizard.
  - Navigate in Windows for Pocket PC.
  - Enter information.
  - Find and organize information.
-

## Hardware features

The illustrations below introduce you to the various buttons, connectors, ports, and other features of your HP Jornada.



1. Stylus.
  2. Carrying pouch.
  3. Stylus slot.
  4. Rubber studs. Remove the studs to add an accessory cover. Note that once removed, the rubber studs cannot be replaced.
  5. Microphone.
  6. Action button. Press to select the highlighted item, or rock to the button to scroll up or down in a document.
  7. Record button. Hold while recording.
  8. HP hot keys. Press to open an application.
  9. Serial port. Connect to your desktop PC using a sync cable or cradle.
  10. DC jack.
  11. On/Off button.
  12. Speaker.
  13. Touch screen.
  14. Notification LED. Signals an alarm or reminder and indicates power status while recharging.
-

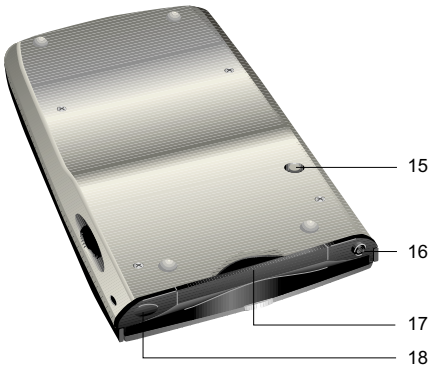

15. Reset button.
16. Stereo headphone jack.
17. CompactFlash card slot. Add memory or accessories using Type I CompactFlash cards.
18. Infrared port. Transfer files and data between other devices without using wires or cables.



HP home menu



Contacts



Calendar



Tasks

### The HP hot keys

## Caring for your HP Jornada

When treated properly, your HP Jornada will be a reliable desktop PC companion. Follow these tips to ensure long and trouble-free use:

- **Protect the screen.** Pressing too hard on the touch screen may damage the screen. To protect the screen, keep your HP Jornada in the carrying pouch while you are not using it. You can also protect the screen with an optional screen protector or a color cover. For more information, see “HP branded accessories” in chapter 8.

Use the stylus to tap the HP Jornada screen to avoid scratches or damage to the screen. To clean the screen, use a small amount of commercial glass cleaner sprayed on a soft cloth. Avoid spraying the screen directly.



---

Be sure to turn off your HP Jornada before cleaning the touch screen.

---

- **Do not drop your HP Jornada.** Dropping or jarring your HP Jornada can cause damage to delicate components such as the display. Accidental damage is not covered under the Hewlett-Packard express warranty.
- **Avoid radiated interference.** Radiated interference from other electronic equipment may affect the appearance of the display of your HP Jornada. Removing the source of the interference will return the display to normal.
- **Avoid high temperatures.** Your HP Jornada is designed to operate at temperatures between 0 to 40 °C (32 to 104 °F). Subjecting the device to temperatures outside this range may damage the unit or result in loss of data. Be especially careful not to leave your HP Jornada in direct sunlight or in a car where temperatures can rise to harmful levels.

## Using your HP Jornada for the first time

Follow these steps to begin using your HP Jornada.

1. **Connect to ac power.** Assemble the ac adapter, and connect it to the dc jack on your Pocket PC.





2. **Reset your HP Jornada.** Press the red Reset button on the back of your Pocket PC.



3. **Follow the Welcome Wizard.** The first time you start your HP Jornada, the Hewlett-Packard Welcome screen appears. Then, after a few moments, the Welcome Wizard begins. The Welcome Wizard presents a brief orientation to Windows for Pocket PC, helps you align the touch screen, and prompts you to select your city and time zone.
  4. **Adjust the display.** Before you begin, you may need to adjust the contrast and brightness of the display to a comfortable level. Press and hold the HP home menu hot key until HP settings appears, and then move the sliders for each setting.
  5. **Register your HP Jornada.** To ensure that you receive warranty coverage, technical support, and information on upgrades, register your HP Jornada at [www.hp.com/jornada](http://www.hp.com/jornada).
-

## Turning your HP Jornada on and off

One of the most convenient features of HP Jornada is “instant on.” With instant on, there is no waiting for HP Jornada to start up or shut down; you can start working immediately by pressing the On/Off button.

---



You can also turn on your HP Jornada simply by tapping the touch screen. On the **Preferences** tab in HP settings, select the **Tap screen to power on** check box.

---

When you are finished working, turn off your HP Jornada by pressing the On/Off button. By default, the backlight will dim after 1 minute of inactivity, and your HP Jornada will turn off automatically after 3 minutes of inactivity if it is not connected to an ac power source. You can use the Power control panel to change these settings. On the **Start** menu, tap **Settings**, tap the **System** tab, and then tap the Power icon.

---



If you select **Tap screen to power on**, your HP Jornada may accidentally turn on when you slide it into the carrying pouch.

---

## Using the hardware buttons and LED

The hardware buttons on your HP Jornada (that is, the buttons on the device itself, rather than buttons or icons that appear on the display) can be used to start a particular program and to turn on your HP Jornada. The features associated with each button are described below. In addition, most buttons can be reassigned or configured to start a program that you designate. For more information, see “Configuring hardware buttons” in chapter 5.

### Notification LED

- A blinking green LED indicates an alarm or reminder. The LED continues blinking until you tap **Snooze** or **Dismiss** on the touch screen.
  - While your HP Jornada is connected to ac power, an amber LED indicates that your HP Jornada is charging. A solid (not blinking) green LED indicates that your HP Jornada is fully charged.
  - A blinking amber LED indicates that the display is off (but the device is still on).
-

## Record button

- Press and release the Record button to turn on your HP Jornada.
- Press and hold the Record button to turn on your HP Jornada and begin recording. If the speaker is not muted, a beep indicates that recording has started.
- Release the Record button to stop recording. If the speaker is not muted, a double beep indicates that recording has stopped.

---

To avoid inadvertently turning on your HP Jornada, you can disable the Record button. For more information, see “Adjusting settings” in chapter 5.

---



## HP hot keys

- Press any HP hot key to start the associated application:



HP home menu hot key



Contacts hot key



Calendar hot key



Tasks hot key

- Press the HP home menu hot key to launch the HP home menu.
  - Press the HP home menu hot key a second time to display the second page of buttons.
  - Press and hold the HP home menu hot key to launch HP settings.
  - Press the Calendar, Contacts, or Tasks hot key to launch that application.
  - In Calendar, Contacts, or Tasks, press the associated hot key again to change views (for example, to switch from Day view to Week view).
  - Press and hold the Tasks hot key to turn the display off (without turning off the device). Press the Tasks hot key (when device is off) to turn the display on again.
  - You can also set the HP hot keys to turn on your HP Jornada and start the associated application with one touch. For more information, see “Adjusting settings” in chapter 5.
-

## On/Off button

- Press the On/Off button to turn your HP Jornada on or off.
- If the display has been turned off, press the On/Off button to turn on the display.
- Press and hold the On/Off button to open the Align Screen application and recalibrate the stylus and touch screen. For more information, see “Aligning the touch screen” later in this chapter.

## Navigating in Windows for Pocket PC

### Using the stylus

Use the stylus to navigate and select objects on the screen:

- **Tap.** Touch the screen once with the stylus to open items and select options.
- **Drag.** Hold the stylus on the screen and drag to select text and images. Drag in a list to select multiple items.
- **Tap-and-hold.** Tap and hold the stylus on an item to see a list of actions available for that item.

For convenience, the stylus is stored in the stylus slot on the carrying pouch of your HP Jornada.

### Aligning the touch screen

From time to time, you might notice that the accuracy of your stylus taps diminishes. When this happens, you can realign your touch screen using the Align Screen control panel.

#### To open the Align Screen control panel

1. On the **Start** menu, tap **Settings**.
2. On the **System** tab, tap the Align Screen icon.
3. Tap the targets as they appear at each new location to calibrate the touch screen.



You can also open the Align Screen control panel—without using the stylus—by pressing and holding the On/Off button.

---

## Today screen

When you turn on your HP Jornada for the first time each day (or after 4 hours of inactivity), you will see the Today screen. You can also display it by tapping **Today** on the **Start** menu. The Today screen displays all the important information about your day. To customize the information that is displayed, tap the Today screen header.

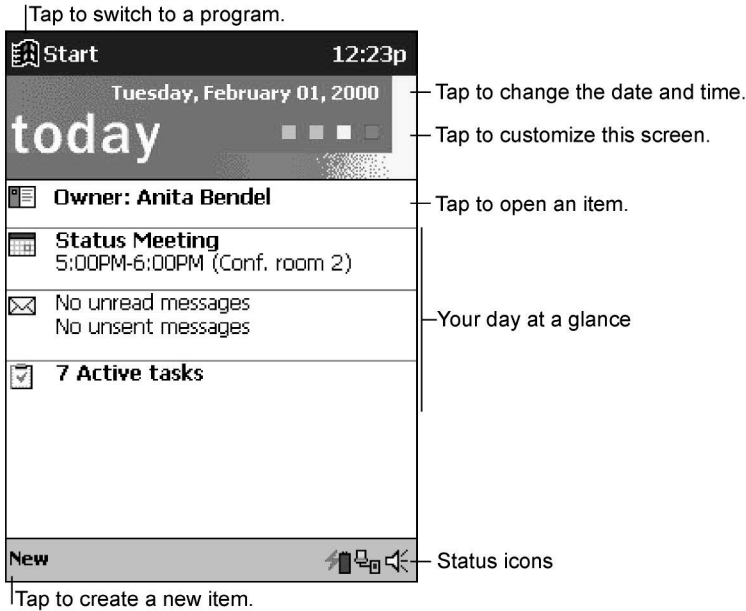

### The Today screen

## Switching programs

Use the HP home menu application or the **Start** menu to quickly launch your favorite programs or open frequently used documents. You can also use HP task switcher to switch between running programs.

### To start or switch programs using HP home menu

1. Press the HP home menu hot key.
2. Tap the button that corresponds to the program or document.

HP home menu displays two pages of buttons and icons that represent the programs and documents on your Pocket PC. To display the second page, press the HP home hot key a second time, or tap the HP home menu icon in the lower-right corner of the HP home menu screen.



The icons displayed on the buttons assigned to the Memory control panel and Power control panel change to indicate when storage memory is low or power is low.

---

### To start or switch programs using the Start menu

1. Tap  in the Navigation bar to display the **Start** menu.
2. On the **Start** menu, tap the name of the program you want to switch to.  
—or—  
Tap one of the miniature icons at the top of the **Start** menu to switch to a recently used program.



You can customize both HP home menu and the **Start** menu to make it easier to access the programs you use most. For more information, see “Configuring menus” in chapter 5.

---

### To switch programs using HP task switcher

1. On the Today screen, tap the HP task switcher status icon  in the Command bar.  
—or—  
Press the HP home menu hot key and tap the HP task switcher icon.
2. On the pop-up menu, tap the name of one of the running programs.

## Navigation bar

The Navigation bar is located at the top of the screen. It displays the active program and current time, and allows you to switch to other programs and close screens.

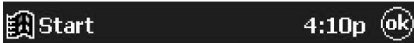

The Windows for Pocket PC Navigation bar

---

## Command bar

Use the Command bar at the bottom of the screen to perform tasks in programs. The Command bar includes the menus and buttons for the active program, status icons, and the Input panel button. To create a new item in the current program, tap **New**.









To see the name of a button, tap and hold the stylus on the button. Drag the stylus off the button so that the command is not carried out.



The Windows for Pocket PC Command bar

## Status icons

When the Today screen is displayed, you may see the following status icons on the Command bar. In most cases, you can tap a status icon to display the associated control panel or more information related to the item. For example, tap the active dial-up connection icon to disconnect from a modem connection.

Icon	Meaning
	Speaker is on.
	Pocket PC is charging.
	Less than 50% power remains.
	Power is very low. A warning message also appears.
	External (ac) power source is connected.
	Dial-up connection is active.
	Direct connection to a desktop PC is active.
	HP task switcher is active.
	HP game buttons are enabled.

## Pop-up menus

Use pop-up menus to choose an action for the selected item. For example, you can use the pop-up menu in the Contact list to quickly delete a contact, make a copy of a contact, or send an e-mail message to a contact. The actions on the pop-up menu vary from program to program. To open a pop-up menu, tap and hold the stylus on the item that you want to perform the action on. When the menu appears, lift the stylus, and then tap the action you want to perform. Tap anywhere outside the menu to close the menu without performing an action.

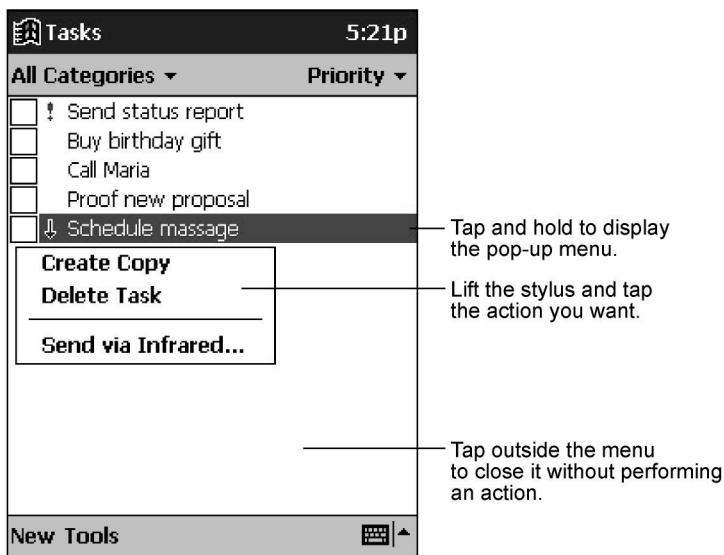

The pop-up menu for Tasks

## Entering information

You have several options for entering information on your Pocket PC:

- Use the soft keyboard on the Input panel to enter text.
- Use the Character Recognizer on the Input panel to enter text.
- Write directly on the screen.
- Speak into the microphone to record a voice note.



## Soft keyboard







The soft keyboard is an onscreen keyboard displayed at the bottom of the screen. Tap a letter on the keyboard to enter that letter, just as if you were typing.

### To display the soft keyboard

1. Tap the Input panel icon at the right edge of the Command bar.

The icon may look like either a keyboard or a pen, depending on which input option you have selected. If  is displayed (meaning that the Character Recognizer is selected), tap the arrow to the right of the Input panel icon, and then tap **Keyboard**.



- To display a numeric keypad, tap  at the upper-left corner of the soft keyboard.
- To type accented characters, tap  at the lower-left corner of the soft keyboard. The display shows the available accented characters.
- To type capital letters, tap the  key.
- To use keyboard shortcuts, such as  for Paste or  for Undo, tap the  key, and then tap the letter of the command.

To change the size of the onscreen keys and set other options for the soft keyboard, tap the arrow next to the Input panel icon and then tap **Options**, or use the Input control panel.

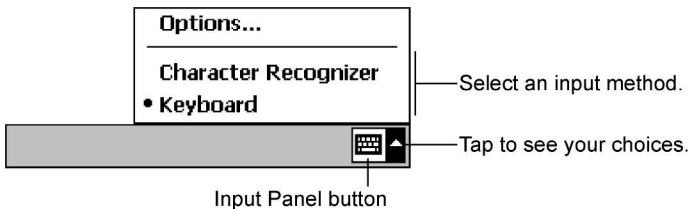

### The Input panel icon and menu

## Character Recognizer

The Character Recognizer is an onscreen writing area that interprets the strokes of your stylus on the screen into typed letters in the active document. You use the stylus to write in the Input panel, just as if you were writing on a piece of paper.

### To display the Character Recognizer

1. Tap the Input panel icon at the right edge of the Command bar.



The Input panel icon may look like either a keyboard or a pen, depending on which input option you have selected. If  is displayed (meaning that the soft keyboard is selected), tap the arrow to the right of the Input panel icon, and select **Character Recognizer**.

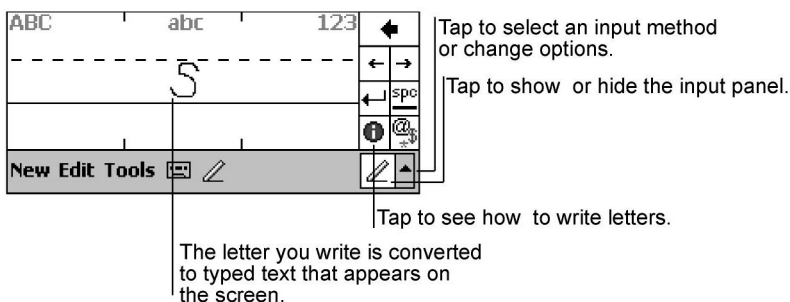

### The Character Recognizer input screen

- To enter capital letters, write in the area at the left of the Input panel under the “ABC” symbol.
- To enter lowercase letters, write in the center portion of the Input panel, under the “abc” symbol.
- To enter numbers and symbols, write in the area at the right of the Input panel, under the “123” symbol.
- To enter symbols, tap the “@\$” symbol to display an onscreen keyboard.

Because certain letters use similar stylus strokes, it may take some practice to achieve the writing style for the Character Recognizer. For a table of stylus motions and the corresponding letters, see Appendix A, “Character recognition.”

---

For a demonstration of proper stylus motions, tap  .

---



---

To select either uppercase or lowercase writing style and set other options for the Character Recognizer, tap the arrow next to the Input panel icon and then tap **Options**, or use the Input control panel.

---



## Writing or drawing on the screen

Some programs, such as Pocket Word, Notes, and the Notes tabs in Calendar, Contacts, and Tasks, accept writing directly on the screen. When you write on the screen, you can edit and format what you have written or convert the information to text.

### To write on the screen

1. Tap  to switch to writing mode.
2. Write on the screen using the stylus, as you would write on paper.

### To convert writing to text

1. Next to the writing you want to convert, tap and hold the stylus until the insertion point appears.
2. Without lifting the stylus, drag it to select the writing.
3. On the **Tools** menu, tap **Recognize**.
4. If the conversion is incorrect, tap and hold the stylus on the incorrect word to display the pop-up menu, and then tap **Alternates**. Tap the word you want to use, or tap the writing at the top of the menu to return to the original writing.

Tips for writing on the screen:

- Write neatly.
  - Write on the lines and draw descenders below the line. Write the cross of the “t” and apostrophes below the top line so that they are not confused with the word above. Write periods and commas above the line.
-

- For better recognition, try increasing the zoom level to 300% using the **Tools** menu.
- Write the letters of a word close together and leave big gaps between words, so that it is clear where words begin and end.
- Hyphenated words, foreign words that use special characters such as accents, and some punctuation cannot be converted.
- If you add writing to a word to change it (such as changing a “3” to an “8”) after you attempt to recognize the word, the writing you added will not be included if you attempt to recognize the writing again.

### To draw on the screen

1. Tap  to switch to writing mode.
2. Draw on the screen using the stylus, being sure to cross three ruled lines on your first stroke.



The first stroke of your drawing must cross three horizontal rules.

---

3. Continue drawing, as you would draw on paper, making sure that subsequent strokes appear in or touching the drawing box.



You may want to change the zoom setting so that you can more easily work on or view your drawing. Tap **Tools** and then select a zoom setting.

---

## Recording voice notes

In any program where you can write or draw on the screen, you can also quickly capture thoughts, reminders, and phone numbers by recording a voice note. In Calendar, Tasks, and Contacts, you can include a recording on the **Notes** tab. In the Notes program, you can either create a standalone recording or include a recording in a written note. If you want to include the recording in a note, open the note first.

You can share voice notes with other Windows-powered devices by sending them over infrared or as an attachment to an e-mail message.

---

The recording feature is intended for recording personal voice notes. It is not suitable for recording presentations, music, or lectures. Some static or electrical noise may be heard during playback.



### To create a recording

1. Press and hold the Record button until you hear a beep. The LED glows amber.
2. While holding the Record button, speak into the microphone. For best results, limit the length of recordings to less than 3 minutes. To create the highest quality recordings, record in a location with low levels of ambient noise, and speak in a normal voice with your mouth approximately 10 cm (4 inches) from the microphone.
3. Release the Record button. Two beeps will sound. The new recording appears in the note list or as an embedded icon.

---

You can also record a voice note by tapping  on the Recording toolbar.



### To play a recording

1. Tap the name of the recording in the file list.
    - or–
    - Tap the recording icon in the note.
    - or–
    - Press the Action button to play the selected recording.
-

## Recording formats

Your HP Jornada supports several formats for voice notes. The formats vary in both the quality of the recording and the size of the sound file. When selecting a recording format, you should consider the quality you need as well as how much storage memory the recording will use on your HP Jornada.

In addition, not all recording formats are compatible with other software or computers. If you will share your recordings with others or transfer a recording to your desktop PC, be sure to choose a recording format that is supported by the software used to play recordings on the other computer. The default recording format is HP Dynamic Voice. For instructions on installing HP Dynamic Voice codec on your desktop PC, see "Installing the HP Dynamic Voice audio codec" in chapter 3.

### To select a recording format

1. On the **Start** menu, tap **Settings**, and then tap the Input icon.
2. On the **Options** tab in the Input control panel, select a voice recording format from the drop-down list.

The table below lists the compatibility of various recording formats with other computers. The list of recording formats on your HP Jornada indicates the sample rate, whether the format is stereo or mono, and how much storage memory is required per second of recording. You may need to experiment with different sample rates and formats to determine which format best suits your voice.

Format	Quality	Compatibility			
		HP Jornada 520 series Pocket PC	Windows CE 2.0 device	PC with ActiveSync installed	Windows 95/98/NT/2000/Me
PCM	High	yes	yes	yes	yes
Mobile Voice	Low	yes	yes	yes	no
GSM 6.10	Medium	yes	yes	no	no
HP Dynamic Voice	High	yes	no	yes*	yes*

---

\* You must first install HP Dynamic Voice codec on your desktop PC. See "Installing the HP Dynamic Voice audio codec" in chapter 3

---

### To send a recording to another computer

1. In the Notes application or in File Explorer, locate the recording you want to send.
2. Tap and hold the name of the recording to display the pop-up menu.
3. On the pop-up menu, tap either **Send via E-mail** or **Send via Infrared**.
4. Enter an e-mail address.  
—or—  
Align the infrared port on your HP Jornada with the infrared port on the recipient's computer. (The recipient's computer must be in infrared receive mode.)

## Finding and organizing information

You can find and organize the files and information on your Pocket PC in much the same way you do on your desktop PC: by using the Find feature or by using File Explorer.

Use the Find feature to locate files that contain a specified text string or that match specific criteria.

### To find a file

1. On the **Start** menu, tap **Find**.
2. In the **Find** box, type the text you want to locate.
3. If you want to narrow your search to files of a specific type, select the file type in the **Type** list.
4. Tap **Go**.

---

To quickly find information that is taking up storage space on your device, select **Larger than 64 KB** in the **Type** list.

---



Use File Explorer to browse the folders on your Pocket PC and to organize files into folders.

### To browse folders

1. On the **Start** menu, tap **Programs**, and then tap **File Explorer**.
-





# 3 | Connecting to your desktop PC

To get the most from your HP Jornada, you will want to connect to your desktop or notebook PC. This chapter describes how to establish the connection between your HP Jornada and your desktop PC, and how to synchronize and transfer files between your Pocket PC and your desktop (or any PC that has Microsoft ActiveSync installed). In this chapter, you will learn to

- Install Microsoft ActiveSync 3.1 on your desktop PC.
  - Connect your HP Jornada by sync cable, cradle, or infrared.
  - Establish a partnership between your HP Jornada and your desktop PC.
  - Synchronize data between your HP Jornada and desktop PC.
  - Browse files on your HP Jornada from your desktop PC.
  - Transfer files between your HP Jornada and a desktop PC.
  - Back up the data on your HP Jornada.
-

## Installing Microsoft ActiveSync on your desktop PC

Before you can connect your HP Jornada to a desktop PC, you must install Microsoft ActiveSync on the desktop PC. Microsoft ActiveSync enables you to browse, synchronize, and transfer files between your desktop PC and your HP Jornada.

Microsoft ActiveSync 3.1 is included on the ActiveSync CD-ROM, which comes with your HP Jornada. For instructions on installing ActiveSync, refer to the *Getting Started with Microsoft ActiveSync* booklet that accompanies the CD-ROM. For information on using ActiveSync, see ActiveSync Help on your desktop PC after you have installed the program.



Check the Microsoft Web site for updates to the ActiveSync software.

---

### System requirements

The minimum desktop PC system requirements for installing and running Microsoft ActiveSync 3.1 are as follows:

- Microsoft Windows 2000, Microsoft Windows NT® Workstation 4.0 with Service Pack 3 or later, Microsoft Windows Me, or Microsoft Windows 95/98
  - Pentium processor for Windows NT or Windows 2000 (166 MHz required for Windows 2000; 150 MHz required for Windows Me); 486/66 DX or higher processor (Pentium P90 recommended) for Windows 95/98
  - 16 MB of memory for Windows 95/98 (more memory will improve performance) or Windows NT (32 MB recommended) or Windows 2000 (64 MB recommended); 32 MB of memory for Windows Me
  - hard disk drive with 10 to 50 MB of available hard disk space (actual requirements will vary based on selection of features and your current system configuration)
  - available 9- or 25-pin communications port (adapter required for 25-pin communication port) or infrared port
  - CD-ROM drive
  - VGA graphics card or compatible video graphics adapter at 256 colors or higher
  - keyboard
  - Microsoft Mouse or compatible pointing device
-

### Optional components

- audio card/speakers for sound
- modem and/or Ethernet LAN connection for remote synchronization
- Microsoft Internet Explorer 4.0 or higher for Mobile Channels or Mobile Favorites support. (Internet Explorer 5.0 is included on the ActiveSync CD-ROM.)
- additional 153 MB of disk space for Microsoft Outlook 2000. 24 MB system RAM recommended. (Microsoft Outlook 2000 is included on the ActiveSync CD-ROM.)

## Installing the HP Dynamic Voice audio codec

HP Dynamic Voice is the default format for recording voice notes on your HP Jornada. You can transfer recordings from your HP Jornada to your desktop PC; however, before you can play a voice note recorded in HP Dynamic Voice on your desktop PC, you must install the HP Dynamic Voice compressor/decompressor (codec). The procedure for installing the codec depends on your operating system. Follow the appropriate instructions below for your version of Microsoft Windows.

### To install HP Dynamic Voice on Windows 95/98/Me

1. Insert the HP Jornada CD-ROM into a drive on your desktop PC.
2. In the HP Dynamic Voice folder on the HP Jornada CD-ROM, open the Win9x folder.
3. Right-click the hpdynv.INF file, and then click **Install** on the pop-up menu.
4. If you are prompted to insert a disk, make sure that your HP Jornada CD-ROM is inserted, and then click **OK**.
5. Installation should begin automatically, and you should see the **Copying Files** dialog box.
6. If you see a message stating that the hpdynv.acm file is not found, click **Browse**, and then select the file from the Win9x folder in the HP Dynamic Voice folder on the HP Jornada CD-ROM.

### To install HP Dynamic Voice on Windows NT

1. Insert the HP Jornada CD-ROM into a drive on your desktop PC.
  2. On the **Start** menu, point to **Settings**, and then click **Control Panel**.
  3. In Control Panel, click **Multimedia**.
  4. On the **Devices** tab, select **Audio Compression CODEC**.
  5. Click **Add**.
-

6. Select **Unlisted or Updated Driver** from the list, and then click **OK**.
7. Click **Browse**.
8. In the **Drives** list, select the drive that contains the HP Jornada CD-ROM.
9. In the **Directories** list, open the HP Dynamic Voice directory, and then select the WinNT directory.
10. Click **OK**. The **Install Driver** dialog box should display the path for downloading HP Dynamic Voice.
11. Click **OK**. The **Add Unlisted or Updated Driver** dialog box should display "Hewlett Packard Dynamic Voice".
12. Click **OK** to install the codec onto your desktop PC.

### To install HP Dynamic Voice on Windows 2000

1. Insert the HP Jornada CD-ROM into a drive on your desktop PC.
  2. On the **Start** menu, point to **Settings**, and then click **Control Panel**.
    1. In Control Panel, double-click the **System** icon.
    2. On the **Hardware** tab, click **Hardware Wizard**.
    3. On the **Welcome to the Add/Remove Hardware Wizard** screen, click **Next**.
    4. On the **Choose a Hardware Task** screen, click **Add/Troubleshoot a device**, and then click **Next**.
    5. In the list of devices, select **Add a new device**, then click **Next**.
    6. In the **Find New Hardware** dialog box, select **No, I want to select the hardware from a list**, and then click **Next**.
    7. In the list of Hardware types, select **Sound, video and game controller**, and then click **Next**.
    8. In the **Select a Device Driver** dialog box, click **Have Disk**, and then click **Browse**.
    9. In the **Drives** list, select the drive that contains the HP Jornada CD-ROM.
    10. In the **Directories** list, open the HP Dynamic Voice directory, select the Win2000 folder, and then click **OK**.
    11. If the **Digital Signature Not Found** dialog box appears, click **Yes** to continue installation.
    12. In the **Select a Device Driver** screen, select **Hewlett-Packard Dynamic Voice**, and then click **Next**.
    13. Click **Next** to start installation.
    14. If the **Digital Signature Not Found** dialog box appears, click **Yes** to continue installation.
    15. Click **Finish** to complete the installation.
-

## Connecting your HP Jornada

You can connect your HP Jornada to a desktop or notebook computer in three ways:

- Use a sync cable to connect to a serial port.
- Use a serial cradle to connect to a serial port.
- Use the infrared port on your Pocket PC (if the desktop or notebook computer also has an infrared transmitter).

Each of these methods works with all models of the HP Jornada Pocket PC. Serial sync cradle and additional sync cables are available as optional accessories. Both serial and infrared connections work with Windows 95, Windows 98, and Windows 2000. Windows NT supports serial connection, but does not support connection by infrared.

Serial connections require a 9-pin serial communications (COM) port on your desktop PC. If the 9-pin serial port is in use by another device, or if your desktop PC has no 9-pin serial port, obtain an adapter from your computer's manufacturer.

### Connecting by sync cable

If a sync cable was not included with your HP Jornada, you can purchase a serial cable as an optional accessory. For more information, see the HP Jornada Accessories Guide.

#### **To connect by sync cable**

1. Connect the sync cable to a serial port on your desktop PC.
  2. Connect the other end of the sync cable to your HP Jornada. Your HP Jornada should start automatically and establish a connection to the desktop PC.
-

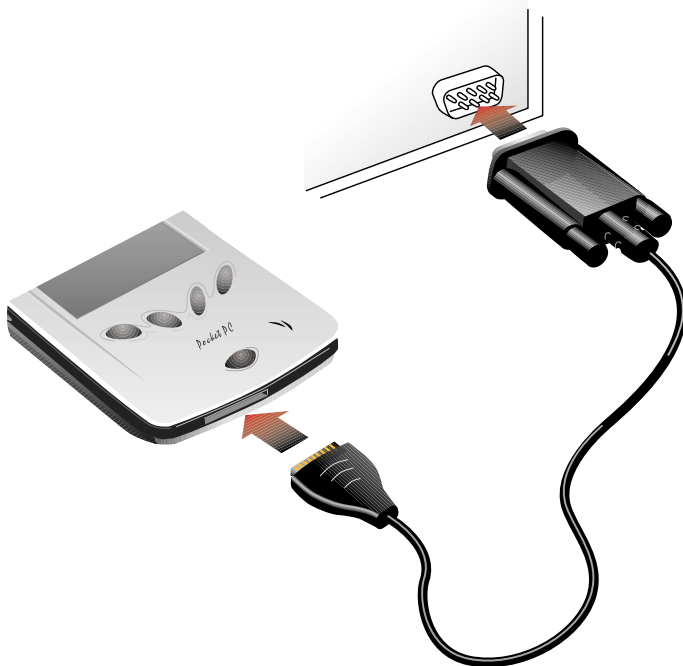

## Connecting by cradle

If a cradle was not included with your HP Jornada 520 Series Pocket PC, you can purchase a serial cradle as an optional accessory. For more information, see the HP Jornada Accessories Guide.

### To connect by cradle

1. Connect the dc plug from the ac adapter to the dc jack on the cradle cable, and plug the ac adapter into a wall outlet.
  2. Connect the cable from the cradle to a serial port on your desktop PC.
  3. Slide your HP Jornada into the cradle. Your HP Jornada should start automatically and establish a connection to the desktop PC.
-



---

When you remove your HP Jornada from the cradle, hold the cradle down with one hand and gently lift the HP Jornada with the other to avoid putting stress on the connectors.

---



## Connecting by infrared

The infrared port on your HP Jornada provides a convenient way to connect to an IrDA-equipped PC without using a cable or cradle. Many notebook computers have built-in infrared ports; however, you may need to install and configure an infrared port on a desktop PC. To install the port, follow the manufacturer's instructions. More information about infrared drivers for Microsoft Windows is available on the Windows for Pocket PC Web site at [www.pocketpc.com](http://www.pocketpc.com).

---

For complete instructions on connecting to your desktop PC by infrared, refer to ActiveSync help on your desktop PC.

## Establishing a partnership

When you install Microsoft ActiveSync, you are prompted to connect your HP Jornada and create a partnership. A partnership enables your desktop PC to recognize your HP Jornada when you connect and to remember the synchronization and file conversion settings you set.

You can connect your HP Jornada to a desktop PC without establishing a partnership; however, only Pocket PCs that have a partnership with a desktop PC can synchronize information between the two computers.

Your HP Jornada can have partnerships with up to two desktop (or notebook) PCs, for example, your home and office computers. If you regularly synchronize your HP Jornada with both desktop PCs, you can ensure that important files, contacts, and appointments are always up-to-date and identical on all three computers.



Although you can establish partnerships with two desktop PCs, you can synchronize e-mail messages with only one desktop PC.

---

A single desktop PC can have partnerships with many Pocket PCs or other mobile devices. This is useful if you have more than one Windows-powered device, or if several mobile professionals share a single desktop PC.

## The New Partnership Wizard

The first time you connect, the New Partnership Wizard on your desktop PC helps you establish a partnership and set options for synchronizing Pocket Outlook data, e-mail messages, and files between your HP Jornada and desktop PC.

### To establish a partnership

1. When the **New Partnership** dialog box appears on your desktop PC screen, click **Yes** to synchronize, and then follow the instructions to complete the New Partnership Wizard.
  2. At the prompt, type a name and description for your HP Jornada. The name must start with a letter, and it can be anything you choose (up to 15 characters, no spaces).
-



---

You can later change the name and description on the **Device ID** tab of the About control panel on your HP Jornada. On the **Start** menu, tap **Settings**, tap the **System** tab, and then tap the About icon.

---



3. Set the number of partnerships your HP Jornada will have. If you will synchronize information between your Pocket PC and more than one computer, or if you have already established a partnership with another desktop PC, select two.
  4. Set options for synchronization, including the types of files and information you want to synchronize and whether to synchronize automatically each time you connect.
- 

If you choose to establish partnerships with two desktop PCs, the two desktop PCs must be configured with the same synchronization settings. In addition, both desktop PCs must use the same PIM program (for example, Microsoft Outlook).

---



## Synchronizing data

Synchronization compares the data on your HP Jornada with the data on your desktop PC and updates both computers with the most recent information. You can synchronize any of the files on your HP Jornada with the corresponding files on your desktop PC. For example

- Keep Pocket Outlook data up to date by synchronizing your Calendar, Contacts, and Tasks databases with Microsoft Outlook on your desktop PC.
- Synchronize Microsoft Word and Microsoft Excel files between your device and desktop PC. Your files are automatically converted to the correct format.
- Synchronize e-mail messages in your HP Jornada Inbox with e-mail messages in Microsoft Outlook on your desktop PC.
- Copy favorite Web site addresses\* and any Web pages you have marked for offline viewing in Microsoft Internet Explorer to your HP Jornada.

By default, ActiveSync synchronizes only Contacts, Calendar, Tasks, and your Mobile Favorites. You can set synchronization options when you first establish a partnership, or use ActiveSync options to turn synchronization on and off for other files and information types.

---

\* Modem must be purchased separately. Some Web sites/content may not be available.

---

Control *when* synchronization occurs by selecting a synchronization mode. For example, you can synchronize continually while your HP Jornada is connected, or only when you choose the **Synchronize** command.

Select which information types are synchronized and control how much data is synchronized. For example, you can choose how many weeks of past appointments you want synchronized.

## Resolving synchronization conflicts

If the same item (for example an appointment or a task) has been modified on both your HP Jornada and desktop PC, ActiveSync indicates that a synchronization conflict has occurred.

When the **Resolve items** message appears in the ActiveSync window, click it to display the **Resolve Conflict** dialog box. To resolve the conflict, you must specify one of the items to replace.

You can resolve each conflict manually at the time of synchronization, or you can resolve conflicts automatically, by setting a default option for conflict resolution.

### To set a default option for conflict resolution

1. In the ActiveSync window on your desktop PC, click **Options** on the **Tools** menu.
2. On the **Rules** tab, choose one of the options under **Conflict Resolution**.

## Synchronizing from a remote location

You can synchronize while connected to your desktop PC by a dial-up modem\* connection or over a local area network (LAN). This can be useful if you need to synchronize files or PIM information while traveling. Before you leave, you must configure both your HP Jornada and your desktop PC.

### On your HP Jornada

You must create a partnership between your HP Jornada and the desktop PC using one of the direct connection methods (serial cable or infrared connection) described in this chapter. And you must configure a dial-up or network connection on your HP Jornada, as described in chapter 4, "Connecting to the Internet or to a network."

---

\* Modem must be purchased separately. Some Web sites/content may not be available.

---

## On your desktop PC

Before you can synchronize remotely, the desktop PC or network server must be configured to allow your HP Jornada to connect. If the desktop PC uses Windows NT or Windows 2000, you must install and configure Remote Access Services. If it uses Windows 95/98/Me, install and configure Dial-Up Networking.

You must also ensure that ActiveSync is configured to allow a network connection. By default, ActiveSync allows a network connection; however, to confirm the setting or to enable connection if it has been disabled, follow the procedure below.

### To enable a network connection in ActiveSync

1. On the **File** menu, click **Connection Settings**.
2. Select **Allow network (Ethernet) and Remote Access Service (RAS) server connection with this desktop computer**.

Follow these steps to prepare your desktop PC before you leave:

- If you are using a modem on your desktop PC, turn the modem on before you leave.
- Leave your desktop PC on, and be sure you logged on under the same user name that you used when you created the partnership.
- Ensure your PIM program and e-mail program (Microsoft Outlook or Microsoft Exchange) are running.

If you receive an error message on your HP Jornada that states that an information type needs attention, or if unresolved items are reported after synchronization, you need to synchronize directly with your desktop PC using a serial cable, cradle, or infrared connection.

## Browsing your HP Jornada from your desktop

While your HP Jornada is connected to a desktop PC, you can use ActiveSync to browse the contents of your HP Jornada from your desktop PC. In the ActiveSync window on your desktop PC, click **Explore** on the **File** menu. The contents of your HP Jornada are displayed in the Mobile Device window.

You can also browse the contents of your HP Jornada from Windows Explorer by double-clicking the Mobile Device icon in My Computer or in the drop-down list of available drives.

While you browse, you can cut, paste, and copy files between folders on your HP Jornada or transfer files between your HP Jornada and desktop PC simply by dragging the file icons between folders.

---

You cannot open documents or start programs stored on your HP Jornada by double-clicking their icons in the Mobile Device window on your desktop PC. Double-clicking an icon displays the properties for that file.

## Transferring files between your HP Jornada and your desktop PC

You can copy files between your HP Jornada and desktop PC by dragging icons to or from the Mobile Device window or by using the **Cut**, **Copy**, and **Paste** commands on the **Edit** menu.

Files created on your desktop PC may need to be converted before you can use them on your HP Jornada, and files created on your HP Jornada may need to be converted before you can use them on your desktop PC. By default, ActiveSync automatically converts files to the appropriate type; however, you can choose not to convert files, or you can choose to specify the conversions for each type of file by changing options in ActiveSync.

### To set file conversion options

1. Start ActiveSync on your desktop PC.
2. On the **Tools** menu, click **Options**.
3. On the **Rules** tab, click **Conversion Settings**.
4. To turn off automatic conversion, clear the **Convert files when synchronized, copied, or moved** check box.

## Backing up and restoring data

To prevent loss of data, you should back up your HP Jornada frequently. You can back up your HP Jornada in two ways:

- Use ActiveSync to back up all data to your desktop PC.
- Use the HP backup application to back up all data or only your Contacts, Calendar, and Tasks databases (PIM data) to a CompactFlash card or to internal memory.



---

Backup files are not password-protected, even if you have set a password for your HP Jornada. If you store sensitive information on your HP Jornada, protect the backup file as you would any other file that contains sensitive information.

---

## Backing up data with ActiveSync

When you back up your HP Jornada using Microsoft ActiveSync, the backup file contains all the files, databases, PIM information, and RAM-based programs on your Pocket PC. The backup file is stored on your desktop PC.

If you have established a partnership between your HP Jornada and desktop PC, you can set ActiveSync to back up data automatically each time you connect. You can also back up your HP Jornada manually any time you want. ActiveSync lets you decide whether to back up all information each time, or only new and updated information.

### To back up data with ActiveSync

1. Connect your HP Jornada to your desktop PC.
2. In the ActiveSync window on your desktop PC, click **Backup/Restore** on the **Tools** menu, and then click the **Backup** tab.
3. Select either **Full Backup** (to back up all information every time) or **Incremental Backup** (to back up only new or updated information).
4. Click **Change** to change the name of your backup file or to specify a location for your backup file.
5. Click **Back Up Now**.

## Backing up data with HP backup

The HP backup application gives you added flexibility in backing up your valuable data. With HP backup, you can back up all data or back up only your Calendar, Contacts, and Tasks databases (PIM databases). You can save the backup file to internal memory or to a CompactFlash card, so you can safeguard your data even while you are traveling or away from your desktop PC.

---

Backing up data to a file stored on your HP Jornada will not preserve your data if your Pocket PC loses power or if you restore your HP Jornada to the factory default settings. To ensure the safety of your data, it is recommended that you back up to a CompactFlash card or to your desktop PC.

---



### To back up data using HP backup

1. Use HP task switcher to close all running applications. (In the Today screen, tap the HP task switcher icon, and then tap **Close Window** and **Close All** on the pop-up menu.)
  2. Disconnect your HP Jornada from your desktop PC.
  3. On the **Start** menu on your HP Jornada, tap **Settings**.
-

4. Tap the **System** tab, and then tap **HP backup**.
5. On the **Backup** tab, tap **Back up all data** or **Back up PIM databases**.
6. In the **Name** box, type a name for the backup file, and select a storage location from the drop-down list.
7. Tap **OK** to start the backup.

The backup file (.dbe or .dbb) is always saved in the My Documents folder. If you back up data to a CompactFlash card, a My Documents folder is automatically created.

## Restoring data

When you use the backup file to restore information to your HP Jornada, information on the device is replaced with the information stored in the backup file. If you have created files on your HP Jornada since the last backup and do not want to delete these files during the restore process, move the files from your HP Jornada to your desktop PC before restoring information. You can restore data using ActiveSync or the HP backup application.

## Restoring data with ActiveSync

---



Restoring data from ActiveSync replaces all information stored on your HP Jornada. Any data added after the backup file was created will be lost.

---

### To restore data with ActiveSync

1. Connect your HP Jornada to your desktop PC.
  2. Use HP task switcher to close all running applications on your HP Jornada. (In the Today screen, tap the HP task switcher icon, and then tap **Close Window** and **Close All** on the pop-up menu.)
  3. In the ActiveSync window on your desktop PC, click **Backup/Restore** on the **Tools** menu, and then click the **Restore** tab.
  4. Click **Restore Now**. Do not use your device until the restore process is complete.
  5. Disconnect the sync cable or remove your HP Jornada from the cradle, remove the CompactFlash card (if installed), and reset your HP Jornada. See “Resetting your HP Jornada” in chapter 9.
-

### Restoring incremental backups

If you have made incremental backups, you must restore each backup file individually, starting with the original (full) backup and progressing in sequence from the oldest to the most recent.

To select the backup file you want to restore, connect your HP Jornada to your desktop PC as a guest. If you have already established a partnership, you must delete the partnership on the desktop PC. (In ActiveSync, click **Delete Partnership** on the **File** menu.)

### Restoring data with HP backup

Use the HP backup application to replace all data on your Pocket PC or only data in your Contacts, Calendar, and Tasks databases (PIM databases) with data from an existing backup file.

---

Depending on the type of backup file, the restore operation replaces all information stored in your PIM databases or all data stored on your Pocket PC. Any data added after the backup file was created will be lost.



#### To restore data with HP backup

1. Use HP task switcher to close all running applications. (In the Today screen, tap the HP task switcher icon, and then tap **Close Window** and **Close All** on the pop-up menu.)
  2. Disconnect your HP Jornada from your desktop PC.
  3. Start HP backup on your HP Jornada.
  4. On the **Restore** tab, tap **Restore all data** or **Restore PIM databases**.
  5. In the file list, tap the name of a backup file you want to restore from.
  6. Remove the CompactFlash card (if installed), and reset your HP Jornada. See “Resetting your HP Jornada” in chapter 9.
-





## 4 | Connecting to the Internet or to a network

In addition to connecting your HP Jornada to your desktop PC partner, you may want to connect to remote computers so you can access e-mail, browse the Internet, or retrieve files from a corporate network (LAN), whether you are at home or on the road. This chapter describes

- the several methods you can use to connect your HP Jornada to a modem,\* cellular phone, or network
- the process of configuring your HP Jornada to connect to an Internet service provider (ISP) or network
- browsing the Web (or a corporate intranet) from your HP Jornada using Microsoft Internet Explorer and Mobile Channels
- sending and receiving e-mail messages with your HP Jornada

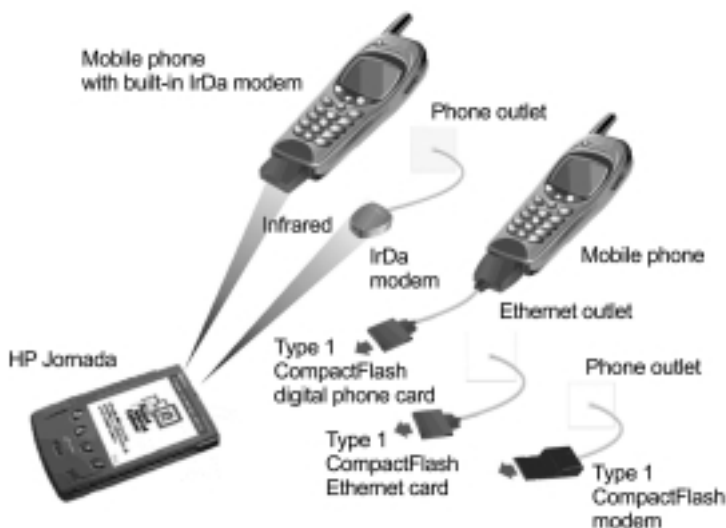

---

\* Modem must be purchased separately. Some Web sites/content may not be available.

---

## Connecting your HP Jornada

Your HP Jornada gives you several options for connecting to a remote computer. You can use an optional CompactFlash card modem, an infrared modem, or a mobile phone. Each of these methods requires purchase of a modem or adapter as an optional accessory. For more information about compatible modems and accessories, visit the HP Jornada Web site at [www.hp.com/jornada/accessories](http://www.hp.com/jornada/accessories).

### Connecting with a CompactFlash card modem

Your HP Jornada Pocket PC supports a variety of Type I CompactFlash card modems and network interface cards (NICs). Whether you use a CompactFlash card modem or CompactFlash NIC, the card must be a Type I CompactFlash card. For a list of compatible CompactFlash cards, go to the HP Jornada accessories page at [www.hp.com/jornada/accessories](http://www.hp.com/jornada/accessories).

Many NICs also require that you install a software driver. The card manufacturer must provide a software driver for the HP Jornada Pocket PC. Follow the card manufacturer's instructions for installing the card and configuring the driver for use with your HP Jornada.



The driver for the Socket Low Power Ethernet CF+ card NIC is preinstalled on your HP Jornada.

---

After you have installed and configured the card, the make and model of the card will appear in the list of modems or the list of network adapters when you create a new connection (see "Creating an ISP or network connection" later in this chapter).

When you are ready to connect, connect the CompactFlash card modem to an analog telephone line or a network connection using the appropriate cable. Follow the card manufacturer's instructions to attach the cable to the port on the card.



Do not connect a CompactFlash card modem to a digital telephone line unless it is specifically designed for use with a digital line.

---



### Type I CompactFlash card slot

## Connecting with an infrared modem

You can also use the infrared port on your HP Jornada to connect to the Internet or a remote computer via an IrDA-compatible infrared modem. When you create a new dial-up connection, select **Generic IrDA modem** from the modem list. Connect the modem to a phone line according to the manufacturer's instructions, and align the infrared port on your HP Jornada with the infrared port on the modem before dialing the call.

## Connecting with a mobile phone

If your mobile phone service supports remote data connection, you can use the mobile phone to connect your HP Jornada to the Internet or to a remote computer. Depending on the make and model of your mobile phone, you can connect your Pocket PC to the mobile phone using either a CompactFlash card interface or the infrared port.

---

### CompactFlash connectivity kit

You may be able to obtain a Type I CompactFlash connectivity kit from the manufacturer of your phone, or from a third-party manufacturer. In either case, the kit must be designed to work with the specific model of your phone, and the manufacturer must provide a driver for use with the HP Jornada Pocket PC.

After you have installed and configured the card, the make and model of the card will appear in the list of modems or the list of network adapters when you create a new connection (see "Creating an ISP or network connection" later in this chapter).

### Via infrared

If your mobile phone has a built-in IrDA-compatible infrared port (or if an optional infrared connectivity kit is available for your phone), you can use the infrared port on your HP Jornada to connect to it. When you create a new dial-up connection, select **Generic IrDA modem** from the modem list. Align the infrared port on your HP Jornada with the infrared port on the mobile phone before dialing the call. For detailed instructions on how to establish a wireless connection using a mobile phone, check the HP Jornada Web site at [www.hp.com/jornada/solutions/hardware/wireless\\_solutions](http://www.hp.com/jornada/solutions/hardware/wireless_solutions).

## Creating an ISP or network connection

To connect to a network or the Internet, you need an account with an ISP, an account on your corporate network, or access permission to dial in to a specific computer.

For each account, you will need a user name and password provided by the ISP or account administrator. If you are connecting to a commercial ISP, you will also need to know the dialup telephone number and IP and DNS addresses (if required).

If you plan to use the account to send or receive e-mail messages directly from your HP Jornada, you must also obtain the following information from your ISP or account administrator:

- a user name and password for your e-mail account (these may be different than the user name and password you use to connect)
  - the name of the POP3 or IMAP4 server (for incoming messages)
  - the name of the SMTP server (for outgoing messages)
-

Before you can use a modem to connect to an ISP or to dial in to a specific desktop PC, you must create a connection for that service on your HP Jornada. If you use an NIC to connect to a corporate network, you must configure your network connection. Your HP Jornada will recognize the connection once you attach the network cable to the NIC.

### To create a dialup connection (to an ISP or a specific PC)

1. Install a modem or NIC. For more information, see “Connecting your HP Jornada” earlier in this chapter.
2. On the **Start** menu, tap **Settings**, and then tap the **Connections** tab.
3. Tap the Modem icon.
4. Tap **New Connection**.
5. Enter a name for the connection. The name can be anything you want, but it should describe the connection, for example, “corporate dialup.”
6. Select the make and model of your modem from the list. If your modem is not listed, it may be installed incorrectly. Refer to the manufacturer’s instructions to be sure.
7. Select the baud rate. The selected rate must be supported by both your modem and the ISP or network computer you will connect to. If you are not sure about the rate, contact your account administrator.
8. If your ISP or account administrator provided specific settings, such as IP addresses, DNS addresses, or parity or flow control—or if your connection uses SLIP—tap **Advanced**, and enter this information on the appropriate tab.
9. Tap **Next**, and then enter the telephone number you dial to connect to your ISP or network computer.
10. Tap **Next**, and then set dialing options.
11. Tap **Finish**.
12. On the **Dialing** tab, select your dialing location and set any necessary options or dialing patterns. (For a description of dialing strings and dialing options, see online Help on your HP Jornada.)

To establish a connection, follow the procedure “To connect to an ISP or desktop PC,” below.

### To configure a network connection

1. On the **Start** menu, tap **Settings**, and then tap the **Connections** tab.
  2. Tap the Network icon.
  3. On the **Adapters** tab, select the name of your CompactFlash card NIC in the list of installed adapters.
-

4. If your ISP or account administrator provided specific settings, such as IP addresses or DNS addresses, enter this information on the appropriate tab, and then tap **OK**.
5. On the **Identification** tab, enter your user name, password, and the domain (if required).

### To connect to an ISP or desktop PC

1. On the **Start** menu, tap **Programs**, and then tap the Connections icon.
2. Tap the icon for the connection. All connections you have created should appear as icons in the Connections folder.
3. Type your user name, password, and domain (if required).
4. Select a dialing location. Tap **Dialing Options** to confirm or change settings for the selected location or to create a new location.
5. In the **Dialing Options** dialog box, tap **Dialing Patterns** to make any necessary changes to the dialing pattern for this call. For an explanation of dialing patterns, see online Help on your HP Jornada.
6. Tap **OK** to close the **Dialing Options** dialog box.
7. Tap **Connect**.
8. In the **Connect To** dialog box, confirm that the proper phone number is displayed. If the phone number is not displayed correctly, adjust the settings in **Dialing Options** or **Dialing Patterns**.



After you have set up an e-mail service, you can also connect to your e-mail server from within Inbox. Select the appropriate service on the **Services** menu, and then tap the Connect button (or tap **Connect** on the **Services** menu). For more information, see "Sending and receiving e-mail" later in this chapter.

---

## Browsing the Web (or a corporate intranet)

Once you are connected, you can browse the Internet or a corporate intranet using Microsoft Pocket Internet Explorer, and you can download mobile channels for offline viewing on your HP Jornada.

### Microsoft Pocket Internet Explorer

You can use Microsoft Pocket Internet Explorer to browse mobile favorites and channels that you have downloaded to your HP Jornada without connecting to the Internet. Or, you can connect to the Internet (or a corporate network) to browse the Web or a corporate intranet.

---



The Pocket Internet Explorer home page

### To browse the Web

1. On the **Start** menu, tap **Internet Explorer**.
2. Connect your HP Jornada to a modem or network. (See “Connecting your HP Jornada” earlier in this chapter.)
3. On the **Tools** menu, tap **Options**, and then tap the **Connections** tab.
4. On the **Connections** tab, select a connection from the **Type** list.
5. If your ISP requires you to connect to a proxy server, select the **Use proxy server** check box, and then enter the address of the proxy server. For more information, consult your account administrator.
6. Tap **OK** to return to Internet Explorer, and then on the **Tools** menu, tap **Connect**.
7. On the **View** menu, tap **Address Bar**, and then type an URL.  
—or—  
Tap , and then tap the favorite you want to view.
8. To close the connection, tap **Tools** and then **Disconnect**.



---

You can have Pocket Internet Explorer automatically connect to the Internet when you attempt to access a page that is not stored on your HP Jornada. On the **Tools** menu, tap **Options**, and then tap the **Connections** tab. Select a connection, and then select the **Access remote content automatically** check box.

---

## Channel content

Channels are Web sites designed specifically for offline viewing on a Pocket PC. You can subscribe to two types of channels at no fee: AvantGo Channels and Mobile Channels provided by Microsoft partners.

### AvantGo Channels

AvantGo is a free interactive service that gives you access to personalized content and thousands of popular Web sites. Unlike Mobile Channels, you can subscribe to AvantGo Channels directly from your HP Jornada. AvantGo Channels are downloaded to your HP Jornada when you synchronize with your desktop PC or when you connect to the Internet. For more information, visit <http://avantgo.com/help>.

#### To sign up for AvantGo

1. In ActiveSync on your desktop PC, click **Options** on the **Tools** menu, and then select the AvantGo information type.
2. In Pocket Internet Explorer on your HP Jornada, tap  to display your list of favorites.
3. Tap the **AvantGo Channels** link.
4. Tap **Activating AvantGo**.
5. Follow the directions on your screen. You will need to synchronize your HP Jornada with your desktop PC, and then tap the My Channels button to complete AvantGo setup.

When synchronization is complete, tap the **AvantGo Channels** link in your list of favorites to see a few of the most popular channels. To add or delete channels, tap the **Add** or **Delete** link.

You can change settings for your AvantGo server or add a specific server for AvantGo channels. On the **Start** menu, tap **Settings**, and then on the **Connections** tab, tap the AvantGo Connect icon.

---



## Mobile channels

Mobile channels are sites you subscribe to on your desktop PC. They are stored in the Channels subfolder in the Mobile Favorites folder of your Microsoft Internet Explorer folder and are downloaded to your HP Jornada during synchronization. To see a list of mobile channels you can subscribe to at no fee, visit the Windows for Pocket PC Web page at [www.pocketpc.com](http://www.pocketpc.com).

While a channel Web page is displayed, click the Add Mobile Channel button, and then select **Make available offline** to download the channel to your desktop PC. The mobile channel will be transferred to your device the next time you synchronize.

### To view channels

1. Tap  to display your list of favorites.
2. Tap the channel you want to view.

Internet Explorer displays the page that was downloaded the last time you synchronized with your desktop PC. If the page is not stored on your HP Jornada, the favorite will be dimmed, and you must synchronize with your desktop PC or connect to the Internet before you can view the page.

## Mobile favorites

When you install ActiveSync, a subfolder called Mobile Favorites is created in the Favorites folder on your desktop PC. You can synchronize the favorites in this subfolder with the favorites on your HP Jornada. Unless you mark the favorite link as a mobile favorite, only the link will be downloaded to your device, and you will need to connect to your ISP or network to view the content.

If you use Microsoft Internet Explorer 5 on your desktop PC, you can mark a link as a mobile favorite, and then download your mobile favorites to your HP Jornada. This enables you to view Web pages while you are disconnected from your ISP and desktop PC. Use the Internet Explorer 5 plug-in installed with ActiveSync to create mobile favorites quickly.

### To create a mobile favorite

1. In Internet Explorer 5 on your desktop PC, click **Tools** and then **Create Mobile Favorite**.
  2. To change the link name, type a new name in the **Name** box.
  3. If you want to update the page on a regular basis, select an update schedule from the **Update** list.
-

4. Click **OK**. Internet Explorer downloads the latest version of the Web page to your desktop PC.
5. If you want to download the pages that are linked to the mobile favorite you just created, in Internet Explorer on the desktop PC, right-click the mobile favorite and then click **Properties**. On the **Download** tab, specify the level of links you want to download.
6. Synchronize your device and desktop PC. Mobile favorites that are stored in the Mobile Favorites folder in Internet Explorer 5 are downloaded to your device.



If you do not specify an update schedule in step 3, you must manually update the information on your HP Jornada. Before you synchronize, in Internet Explorer on your desktop PC, click **Tools** and then **Synchronize**. Check the last time content was downloaded, and manually download content if needed.

---



You can add a button to the Internet Explorer toolbar for creating mobile favorites. In Internet Explorer 5 on your desktop PC, click **View**, **Toolbars**, and then **Customize**.

---

### To view mobile favorites

1. Tap  to display your list of favorites.
  2. Tap the mobile favorite you want to view.  
You will see the page that was downloaded the last time you synchronized with your desktop PC. If the page is not on your device, the favorite will be dimmed, and you will need to synchronize with your desktop PC or connect to the Internet to view the page.
-



### Mobile favorites

#### Conserving memory

Mobile favorites can use a lot of storage memory on your HP Jornada. Follow these tips to minimize the amount of memory used:

- Turn off pictures and sounds or stop some mobile favorites from being downloaded to your HP Jornada. In ActiveSync on your desktop PC, click **Options** on the **Tools** menu, select the Favorites information type, and then click **Settings**. For more information, see ActiveSync Help.
- Limit the number of downloaded linked pages. In Internet Explorer on the desktop PC, right-click the mobile favorite you want to change, and then click **Properties**. On the **Download** tab, specify 0 or 1 for the number of linked pages you want to download.

## Sending and receiving e-mail

Your HP Jornada includes Inbox, a full-featured e-mail program that is part of Microsoft Pocket Outlook. You can use Inbox to send and receive e-mail messages either by synchronizing messages with Microsoft Exchange or Microsoft Outlook on your desktop PC, or by connecting directly to an e-mail server through an ISP or a network.

## Sending and receiving messages via your desktop PC

You can send and receive messages on your HP Jornada via the e-mail service on your desktop PC by synchronizing your Inbox. When you enable Inbox synchronization in ActiveSync options, messages are transferred from the Inbox and Outbox on your HP Jornada to the corresponding folders on your desktop PC each time you synchronize.

### To enable Inbox synchronization

1. In ActiveSync on your desktop PC, click **Options** on the **Tools** menu, and then select the Inbox information type.

When you synchronize

- E-mail messages in the Inbox folder of desktop versions of Microsoft Exchange or Outlook are copied to the Inbox folder on your HP Jornada. The e-mail messages on the two computers are linked, so when you delete an e-mail message on your HP Jornada, it will be deleted from your desktop PC the next time you synchronize.
- E-mail messages in the Outbox folder on your device are transferred to the Outbox in Microsoft Exchange or Outlook on your desktop PC. The messages are sent the next time you send mail from your desktop PC.



You can only synchronize e-mail messages with a single desktop PC. If you have established partnerships between your HP Jornada and two desktop PCs, you can synchronize your Inbox with only one of them.

---

## Sending and receiving messages with Inbox

If you have an e-mail account with an ISP or on a corporate network, you can connect to the e-mail server for that account with a modem or network card, and then use Inbox to send and receive e-mail messages directly.

When you connect to the e-mail server, new messages are downloaded to the Inbox folder on your HP Jornada, messages in your Outbox folder are sent, and messages that have been deleted on the e-mail server are deleted from the Inbox folder.

Messages that you receive directly from an e-mail server (rather than from your desktop PC) remain linked to the e-mail server. If you delete a message on your HP Jornada, the message will be deleted from the e-mail server the next time you connect.

---

You can work with e-mail messages online or offline. When working online, you read and respond to messages while connected to the e-mail server. Messages are sent as soon as you tap **Send**, which saves space on your device.

When working offline, you can disconnect from the e-mail server, review the message headers or messages that you downloaded, and then decide which messages you want to download completely. The next time you connect, Inbox downloads the complete messages you have marked for retrieval and sends the messages you have composed. Working offline reduces the time you are connected and can save money, especially if you are dialing long distance.

To retrieve messages from an e-mail account, you must set up a service for that account. The service includes your account information, message delivery options, and a link to a dial-up or network connection.

### To create an e-mail service

1. On the **Start** menu, tap **Programs**, and then tap the Inbox icon.
2. On the **Services** menu, tap **New Service**.
3. Select a service type (IMAP4 or POP3) and type a name for the service. The name can be anything you choose. If you are not sure what type of service is associated with your account, consult your account administrator. Tap **Next**.
4. If you connect to your mail server using a modem, select a dial-up connection from the drop-down list.  
 –or–  
 If you connect to your mail server over a network connection, select **Network Connection** from the drop-down list.  
 –or–  
 Select **Create new connection** to create a new dial-up connection for this service. For more information on creating a dial-up connection, see “Creating an ISP or network connection” earlier in this chapter.
5. Type the name of your e-mail server, your e-mail user name, and your password.
6. Enter the domain (if required for Windows NT networking), the address of your outgoing (SMTP) mail server, and the return address for replies to your messages. Tap **Next**.
7. Set message delivery options for your service, and then tap **Finish**.

To connect to your e-mail server from within Inbox, select the appropriate service on the **Services** menu, and then tap the Connect button (or tap **Connect** on the **Services** menu).

---

## Working with messages on your HP Jornada

### Using the message list

Messages you receive are displayed in the message list. By default, the most recently received messages appear first in the list. Unread messages are displayed in bold.

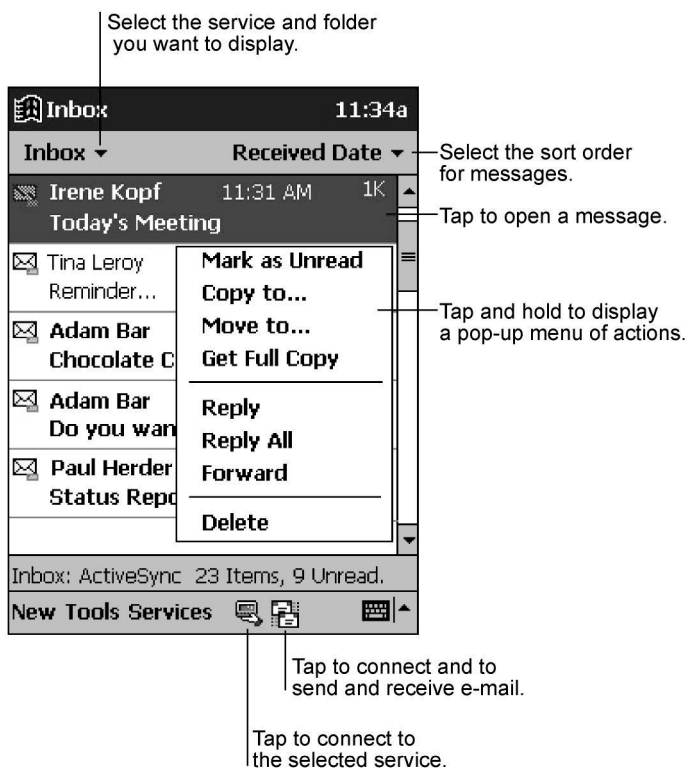

### The Inbox message list

#### To read a message

- In the message list, tap the icon of the message you want to read.
  - To reply to or forward the message, tap .
  - To read the next message, tap the down arrow on the Command bar.

- To delete a message, tap . If your messages are still linked to messages on your e-mail server or desktop PC, they will be stored in the Deleted (local) folder. If your messages were downloaded directly from an e-mail server, they will be deleted from both your HP Jornada and the e-mail server.

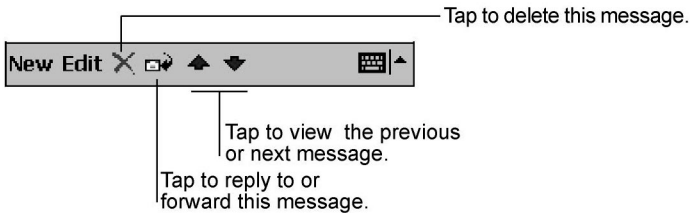

### The Read Message Command bar

By default, Inbox downloads only the first 100 lines of each new message when you connect to your e-mail server or synchronize with your desktop PC. No e-mail attachments are downloaded. The original messages remain on the e-mail server or your desktop PC. If you want to read the full message with attachments, you must mark the message in Inbox, and then connect to the mail server or synchronize again.

#### To mark a message for retrieval

1. In the message list, tap and hold the message you want to retrieve.
2. On the pop-up menu, tap **Get Full Copy**.

You specify your downloading preferences when you set up the service or select your synchronization options. You can change them at any time:

- Change options for Inbox synchronization using ActiveSync options. For more information, see ActiveSync Help.
- Change options for direct e-mail server connections in Inbox on your HP Jornada. On the **Tools** menu, tap **Options**. On the **Services** tab, tap the service you want to change.

### Composing e-mail messages

#### To compose an e-mail message

1. Tap **New**.
2. In the **To** box, enter an e-mail address or select a name from the Contact list by tapping the Address Book button on the Command bar.

3. Compose your message.
4. To attach a file, tap the attachment icon.



When you send a file as an attachment, be sure the message recipient can read the type of file you are sending. If the recipient does not have a Windows-powered Pocket PC, be sure you save the file in an alternative format.

---

5. Tap **Send** when you have finished the message.

The message is placed in the Outbox folder on your device and will be delivered the next time you connect to your e-mail server or synchronize messages with your desktop PC.

### Managing e-mail messages and folders

By default, messages are displayed in one of four folders for each service you have created: Inbox, Deleted (local), Outbox, and Sent. The Deleted (local) folder contains messages that have been deleted on your HP Jornada, but are still linked to messages on your e-mail server or desktop PC.

---



If you are using IMAP4, you may see a Deleted Items folder. This folder is for messages deleted on the e-mail server.

---

The behavior of the Deleted (local) and Sent folders depends on the options you have chosen. In the message list, tap **Tools** and then **Options**. On the **Message** tab, select your options.

If you want to organize messages into additional folders, tap **Tools**, and then **New Folder** to create new folders. To move or copy a message to another folder, tap and hold the message in the message list, and then tap **Move to** or **Copy to** on the pop-up menu.

Moving an e-mail message into a folder you create breaks the link between the messages on your HP Jornada and the copy on your desktop PC or POP3 e-mail server. The next time you synchronize, the message may be deleted from the Inbox folder on the mail server or desktop PC. This prevents you from storing duplicate copies of an e-mail message, but it also means that you will no longer have access to the e-mail messages you moved out of Inbox except from your HP Jornada. If you have an e-mail account on an IMAP4 mail server, the folders you create and the messages you move will be duplicated on the e-mail server.

---



# 5 | Configuring your HP Jornada

This chapter details ways you can optimize your HP Jornada using settings and the HP applications, and describes ways you can expand the features and functionality by adding programs. This chapter also offers important tips on safeguarding your data by managing power and memory and using the security settings.

In this chapter, you will learn to

- Manage power effectively.
  - Manage the memory on your HP Jornada.
  - Adjust settings for the display and sounds.
  - Use security features to protect your data.
  - Configure hardware buttons for games.
  - Configure menus for easy access to programs and documents.
  - Add or remove programs.
-

## Managing power

Because the data and files you save on your HP Jornada are stored in RAM, maintaining a continuous power supply to the HP Jornada at all times is extremely important. If your HP Jornada runs out of power, all information you have entered is lost. Although the Windows for Pocket PC operating system and programs cannot be erased, any custom settings and programs you have added are erased if you lose power.

Under typical usage conditions, your HP Jornada should operate for approximately 8 hours between charges. Some functions, such as listening to music or using CompactFlash cards, use considerable power and may reduce this time significantly.

You should respond as soon as possible when your HP Jornada displays a dialog box warning of low power. If you continue to use your HP Jornada until power reaches a critical low condition, a **Battery very low** message appears, and the device shuts down automatically. You will be unable to use your Pocket PC until you connect to external power for charging. Data will be retained for up to 5 days.

Because your HP Jornada is charged automatically whenever it is connected to ac power, simply connect the HP Jornada to ac power to recharge when the power is low. While your HP Jornada is connected to ac power, the Notification LED indicates the charging status:

- Amber indicates that the battery is charging (connected to ac power).
- Green indicates that the battery is fully charged.

### To check the remaining power

1. On the **Start** menu, tap **HP settings**. The remaining power is displayed on a status bar at the bottom of the **Settings** tab.
- 



Under certain conditions, the power status icon is displayed on the Command bar in the Today screen. Simply tap the power status icon to open the Power control panel.

---

Follow these tips to ensure the longest use of your HP Jornada between charges:

- Use the Power control panel to set your HP Jornada to turn off after a short period of inactivity.
  - Use the Backlight control panel to set the backlight to dim after a short period of inactivity.
-

- If you are playing music or using other functions that do not require the display, turn off the display by pressing and holding the Tasks hot key. (Turn on the display by pressing the Tasks hot key again or by pressing the On/Off button.)

## Managing memory

The memory on your HP Jornada is allocated between storage memory and program memory. Windows for Pocket PC automatically manages the allocation between storage and program memory; however, in some situations (such as when memory is low), it may not be able to automatically adjust the allocation. If you receive a message stating that storage or program memory is unavailable, try the following solutions.

### Increasing storage memory

You can try any or all of these solutions to increase storage memory:

- Buy an optional Type I CompactFlash memory card, and move files from internal memory to the card. (For more information on CompactFlash cards, see “CompactFlash cards” in chapter 8.)
- Delete unnecessary files.
- Remove Web pages stored for offline viewing in Internet Explorer folders.
- Remove programs you no longer use. See “Adding or removing programs” later in this chapter.
- Clear program memory. See “Increasing program memory,” below.

### Increasing program memory

You can try any or all of these solutions to increase program memory:

- Use HP task switcher or the Memory control panel to stop programs you are not currently using. In most cases, programs automatically stop to free needed memory. However, in some situations, such as when a dialog box is waiting for a response, the program may not be able to stop automatically.
  - Clear storage memory as described in the preceding section. This will free some storage memory so that it can be reallocated as program memory.
  - Disconnect the sync cable or remove your HP Jornada from the cradle, remove the CompactFlash card (if installed), and reset your HP Jornada. See “Resetting your HP Jornada” in chapter 9.
-

### To use the Memory control panel to stop programs

1. Open the Memory control panel, and then tap the **Running Programs** tab.
2. Select a program in the list, and then tap **Stop**.

### To use HP task switcher to stop programs

1. In the Today screen, tap the HP task switcher icon.
2. On the pop-up menu, tap **Close Window** and then tap **Close All**.

## Adjusting settings

Use the HP settings application to quickly change settings such as screen brightness and contrast and speaker volume, to display system information such as memory status and remaining power, and to change display, button, and power driver settings.

### To start HP settings

1. On the **Start** menu, tap **HP settings**.  
—or—  
Press and hold the HP home menu hot key.

## The Settings tab

On the **Settings** tab you can adjust the screen brightness and contrast, adjust the speaker volume to suit your work environment, and check the remaining power. You can also mute the speaker by selecting the speaker mute check box.

---

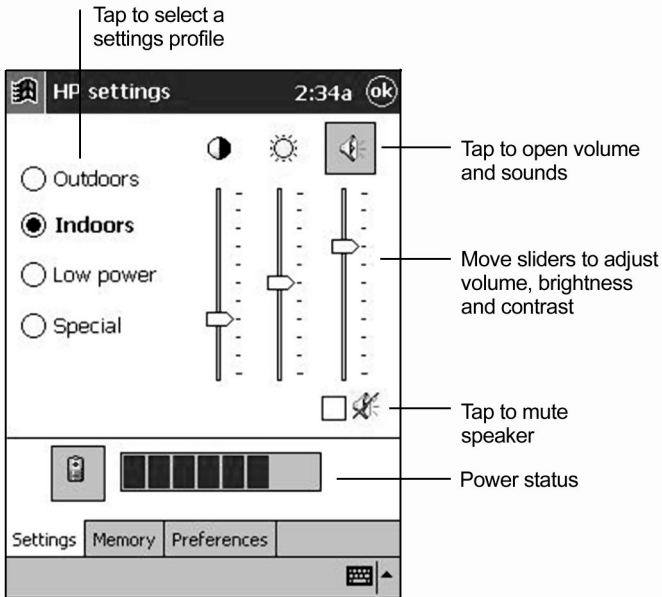

## HP settings

To change the speaker volume settings, you can quickly switch to the Sounds & Reminders control panel by tapping the Speaker button.



Save your preferred settings to any of the four profiles. Select the profile you want to change, and then adjust the sliders to fine-tune the settings.

The remaining power is displayed on a status bar at the bottom of the **Settings** tab. To switch to the Power control panel, tap the battery icon next to the power status bar.

## The Memory tab

The **Memory** tab displays total and available (free) Storage, Program, and Storage Card memory. For information on allocating memory between storage and programs, see "Managing memory" earlier in this chapter.

## The Preferences tab

Use the **Preferences** tab to customize button settings and certain power options.

To prevent inadvertently turning on your Pocket PC, you can disable the Record button. On the **Preferences** tab, select the **Disable record button** check box.

You can also set your Pocket PC to turn on when you press one of the HP hot keys. On the **Preferences** tab, clear the **Disable HP hot keys** check box. (By default, the HP hot keys are disabled to prevent you from inadvertently turning on your Pocket PC.)

You can set your Pocket PC to turn on whenever you tap the touch screen. On the **Preferences** tab, select the **Tap screen to power on** check box.

## Security

This section provides some tips to safeguard your HP Jornada and the data it holds from theft or loss. You can set a password to protect your data and keep a record of when someone tries to access data on your HP Jornada.

### Setting a password

Use the HP security application to prevent unauthorized access to your HP Jornada and the data it holds. You can set a password to protect your data, set a reminder password, and keep a record of when anyone attempts to access data on your HP Jornada.

If you enable password protection, you must enter your password each time you turn on your Pocket PC. Or, you can set a short delay, so you do not need to re-enter your password if you turn on your HP Jornada within a short period of time. The delay feature can be convenient if you frequently turn your HP Jornada on and off to conserve power.

#### To set a primary password

1. On the **Start** menu, tap **Settings**, and then on the **Personal** tab, tap the HP security icon.
2. On the **Primary** tab, enter a four-digit password by tapping the onscreen keypad.
3. Select the **Enable password protection** check box.



If you forget your password, you must restore your HP Jornada to the factory default settings. This will erase all data you have stored on your HP Jornada. For more information, see “Resetting your HP Jornada” in chapter 9.

---

### To create and enable a reminder password

1. On the **Start** menu, tap **Settings**, and then on the **Personal** tab, tap the HP security icon.
2. On the **Reminder** tab, use the Input panel to enter a question in the **Question** box.
3. In the **Answer** box, enter the answer to your reminder question.
4. Select the **Enable reminder password** check box.
5. In the **Prompt after** box, enter the number of times you want to try your primary password before HP security prompts you with the question for your reminder password.

When you tap **OK**, your changes are saved and password protection is enabled. You must enter the password each time you start your HP Jornada and each time you open the HP security application.

### To set a password delay

1. Set your primary password.
2. Select the **Delay activation after suspend for** check box.
3. Using the input panel, enter a number of minutes for the delay.

### To clear your password

1. On the **Primary** tab, tap CLR on the numeric keypad.

## Creating a security log

You can also use the HP security application to record all attempts to access your HP Jornada, and any attempts to modify the password settings. You can view the log on your HP Jornada or export it as a file to save or edit on your desktop PC.

### To enable security logging

1. On the **Log** tab, select the **Enable logging** check box.
  - Entries appear in the table on the **Log** tab.
  - To clear all entries, tap **Clear Log**.
  - To export the log to a file, tap **Export Log**.

## Adding owner information

If you lose your HP Jornada, owner information can provide an easy way for someone to identify you as the owner and to return your Pocket PC. Use the Owner Information control panel to enter or update this information.

---

### To add or change owner information

1. On the **Start** menu, tap **Settings**, and then tap the Owner Information icon.
2. On the **Identification** tab, enter, your name, address, and/or other information.
3. On the **Notes** tab, type any other information you want displayed (for example, a temporary address, or an offer of a reward for the safe return of your HP Jornada).



To display your owner information each time you turn on your HP Jornada, select the **Show information when device is turned on** check box.

---

## Configuring hardware buttons

You can configure the hardware buttons on your HP Jornada to suit the way you work. Individual buttons can be assigned to different programs using the Buttons control panel, and the HP game buttons application enables you to create hardware profiles for specific games.

### The Buttons control panel

Use the Buttons control panel to assign any of the HP Jornada hardware buttons—the HP hot keys and the Record button—to any program. You can also customize the Action button to control the speed at which you scroll through documents.

#### To assign a program to a hardware button

1. On the **Start** menu, tap **Settings**, and then tap the Buttons icon.
2. On the **Program Buttons** tab, select a button from the list.
3. In the **Button assignment** list, select the program you want to assign to the button.

#### To control the scroll speed

1. On the **Start** menu, tap **Settings**, and then tap the Buttons icon.
  2. On the **Up/Down Control** tab, move the sliders to set the repeat rate and the delay before repeat.
-



## HP game buttons

The HP game buttons application makes it easier to enjoy your favorite games on your HP Jornada. Use HP game buttons to assign game actions to the hardware buttons of your Pocket PC.

### To start HP game buttons

1. On the **Start** menu, tap **Settings**.
2. Tap the **System** tab, and then tap the HP game buttons icon.
3. Select the **Enable mapping** check box to activate the gaming buttons.
4. In the drop-down list, select a game profile to use or modify, or create a new game profile.

---

To make it easy to enable or disable the game buttons, select the **Show status icon** check box. The HP game buttons status icon will appear in the Command bar of the Today screen. Simply tap the status icon to enable or disable the gaming buttons.



### Creating a game profile

You can create a different profile for each of your favorite games by assigning the hardware buttons on your Pocket PC to the actions associated with each game.

### To create a game profile

1. Start the HP game buttons application.
  2. Tap the drop-down list of game profiles. The Input panel appears.
  3. Using the Input panel, enter a name for the profile.
  4. In the settings list, select an action, and then press the hardware button you want to assign to the action.
  5. Repeat step 4 until you have assigned all the important game actions to hardware buttons.
-

## Configuring menus

You can customize the menus on your device to ensure you have easy access to programs or documents.

### HP home menu

Use the HP home menu application to quickly launch your favorite programs or open frequently used documents. You can modify each of the 21 buttons on the HP home menu by adding descriptions or by assigning them to the programs or documents you use most.

#### To modify a button assignment

1. Press the HP home menu hot key to open HP home menu. To display the second page of buttons, press the hot key a second time, or tap the HP home menu icon in the lower-right corner of the HP home menu screen.
  2. Tap and hold the stylus on the button you want to modify.
  3. On the pop-up menu, tap **Assign**, **Rename**, or **Delete**.
    - Assign—Tap **Assign**, and then browse to select the program or document you want to assign to the button.
    - Rename—Tap **Rename**, and then type a description to be displayed under the button. The description can be up to 10 characters long. The default description is the file name.
    - Delete—Tap **Delete** to clear the current button assignment.
-

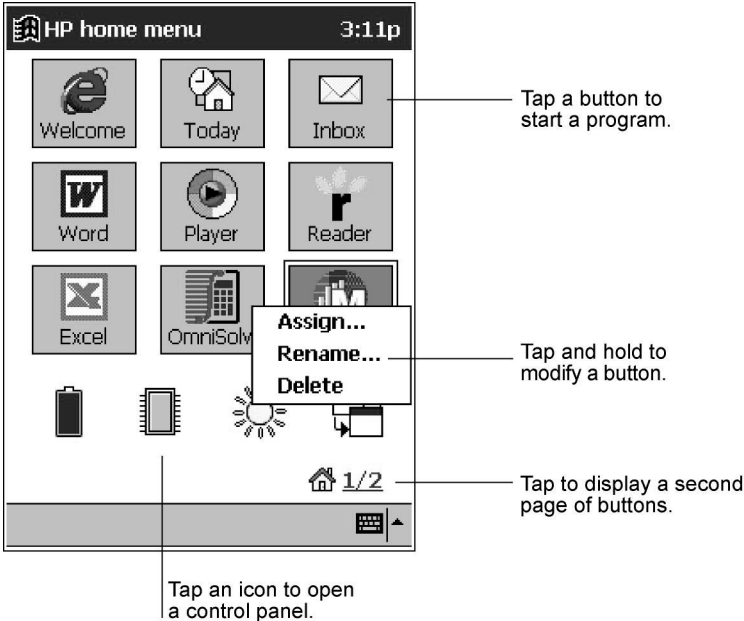

### The HP home menu screen

## Start menu

You can also add or remove programs from the **Start** menu to make it easier to access the programs you use most.

### To add a program to the Start menu

1. On the **Start** menu, tap **Settings**, and then tap **Menus**.
2. On the **Start Menu** tab, select the check box for the program you want to add.

The **Start Menu** tab displays only the programs stored in the Start Menu folder on your HP Jornada. If you do not see a particular program listed, use File Explorer to move the program to the Start Menu folder.

## New menu

You can also add or remove programs from the **New** menu to make it easier to create documents in common programs.

### To add a document to the menu

1. On the **Start** menu, tap **Settings**, and then tap **Menus**.
2. On the **New Menu** tab, select the **Turn on New button menu** check box, and then select the document types you want to appear on the menu.

## Adding or removing programs

### Installing programs

You can add even more functionality to your HP Jornada by installing additional software and programs. A wide variety of software is available for Windows for Pocket PC, ranging from custom business applications and system utilities to games and entertainment. Some programs are available on the CD-ROMs included with your HP Jornada. Other programs are available from software vendors or on the Web.



---

The only programs that will run on your HP Jornada are those designed specifically to run on Windows for Pocket PC. You cannot run programs designed for Windows 95, 98, 2000, Me, or NT on your HP Jornada. In addition, you may need a version of the program designed specifically for the SH3 processor.

---

Install software to your HP Jornada by first loading the installation files onto your desktop PC, and then using ActiveSync or running the Application Manager.

### To install programs

1. Download the software program or installer from the Web to your desktop PC.  
—or—  
Insert the floppy disk or compact disk into the appropriate drive on your desktop PC.
  2. Connect your HP Jornada to your desktop PC.
  3. If the program includes an installer program (typically named Setup.exe or Install.exe), double-click the installer program on the desktop PC. The installer program copies the necessary files to the HP Jornada.
-

---

If the program does not have an associated installer or setup program, drag the program file (typically an \*.exe file type) to the HP Jornada icon in the ActiveSync window. If the **No Converter Selected** dialog box appears, tap **OK** to copy the file without conversion. Software installed in this way may not appear on the **Remove Programs** list, and you may have to delete the program manually if you wish to remove it from the HP Jornada.

---



### To add programs with Application Manager

1. Connect the HP Jornada to your desktop PC, and then open the ActiveSync window.
2. On the **Tools** menu in the ActiveSync window, click **Add/Remove Programs**.
3. Select the check box for the program you want to add.

## Removing programs

To free storage memory on your HP Jornada, you can remove programs you no longer use. Only programs you have added can be removed; that is, only programs that are stored in RAM. The preinstalled programs—programs stored in ROM—cannot be removed; however, these programs do not use storage memory.

### To remove a program

1. On the **Start** menu, tap **Settings**.
2. On the **System** tab, tap **Remove Programs**.
3. Select the program in the list, and then tap **Remove**.

---

If the program does not appear in the list of installed programs, use File Explorer on your device to locate the program, tap and hold the program, and then tap **Delete** on the pop-up menu.

---





# 6 | Microsoft Pocket Outlook

Microsoft Pocket Outlook includes Calendar, Contacts, Tasks, Inbox, and Notes. You can use these programs individually or together. For example, e-mail addresses stored in Contacts can be used to address e-mail messages in Inbox.

Using ActiveSync, you can synchronize information in Microsoft Outlook or Microsoft Exchange on your desktop PC with information in Pocket Outlook on your HP Jornada. Each time you synchronize, ActiveSync compares the changes you made on your device and desktop PC and updates both computers with the latest information. For information on using ActiveSync, see ActiveSync Help on your desktop PC.

In this chapter, you will learn to

- Schedule appointments and meetings using Calendar.
  - Keep track of friends and colleagues using Contacts.
  - Keep a to-do list in Tasks.
  - Capture thoughts and ideas with Notes.
-

## Calendar: scheduling appointments and meetings

Use Calendar to schedule appointments, including meetings and other events. You can check your appointments in one of several views (Agenda, Day, Week, Month, and Year) and easily switch views by using the **View** menu.

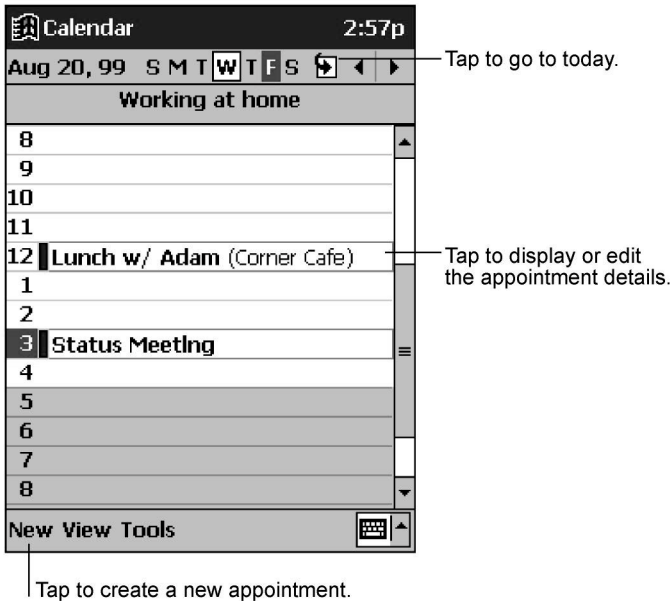

### The Day view in Calendar

When you tap an appointment in Calendar, a summary screen of the information you entered is displayed. Tap the top portion of the summary screen to change the appointment information.



You can customize the Calendar display—for example, changing the first day of the week—by tapping **Options** on the **Tools** menu.

### To create an appointment

1. In Day or Week view, tap the desired date and time for the appointment.
2. Tap **New**.



3. Using the Input panel, enter a description and a location for the appointment.
4. If needed, tap the date and time to change them.
5. Enter other desired information. (You may need to hide the Input panel to see all available fields.)
6. To add notes, tap the **Notes** tab. You can enter text, draw, or create a recording. For more information on creating notes, see “Notes: capturing thoughts and ideas” later in this chapter.
7. When you are finished, tap **OK** to return to Calendar.

---

If you select **Remind me** in an appointment, your HP Jornada will remind you according to the options you set in the Sounds & Reminders control panel.

---



## Creating meeting requests

You can use Calendar to set up meetings with users of Outlook or Pocket Outlook. A meeting notice is created automatically and sent either when you synchronize Inbox or when you connect to your e-mail server. Indicate how you want meeting requests sent by tapping **Tools** and then **Options**. If you send and receive e-mail messages through ActiveSync, select **ActiveSync**.

### To schedule a meeting

1. Create an appointment.
2. In the appointment details, hide the Input panel, and then tap **Attendees**.
3. From the list of e-mail addresses you have entered in Contacts, select the meeting attendees.

The meeting notice is created automatically and placed in the Outbox folder.

For more information on sending and receiving meeting requests, see Calendar Help and Inbox Help on your HP Jornada.

## Contacts: tracking friends and colleagues

Contacts maintains a list of your friends and colleagues so that you can easily find the information you are looking for, whether you are at home or on the road. Using the infrared port on your HP Jornada, you can quickly share Contacts information with other Windows-powered devices.

---

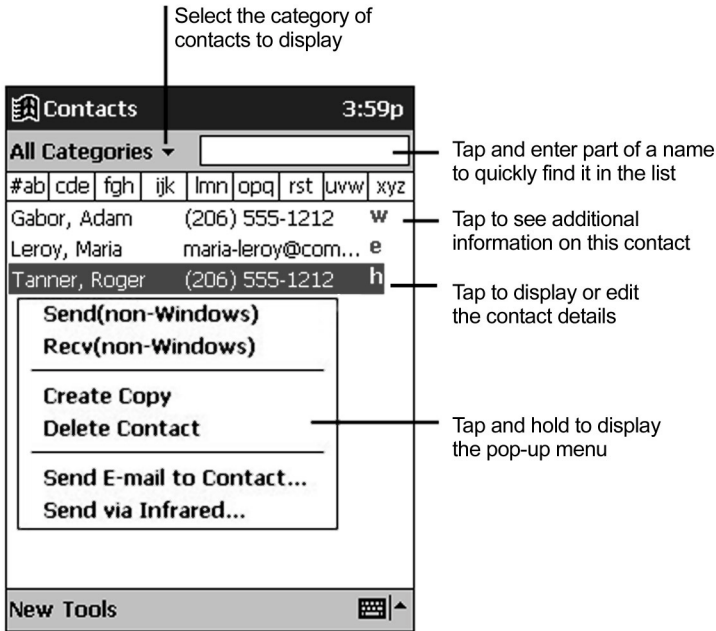

### The Contacts list

When you tap a contact in the Contact list, a summary screen of the information you have entered is displayed.



To change the way contacts are displayed in the list, tap **Tools** and then **Options**.

### To create a contact

1. Tap **New**.
2. Using the Input panel, enter a name and other contact information. You will need to scroll down to see all available fields.
3. To assign the contact to a category, scroll to and then tap **Categories**. Select a category from the list. In the Contact list, you can display contacts by category.
4. To add notes, tap the **Notes** tab. You can enter text, draw, or create a recording. For more information on creating notes, see “Notes: capturing thoughts and ideas” later in this chapter.
5. When finished, tap **OK** to return to the Contact list.

## Tasks: keeping a to-do list

Use Tasks to keep track of what you have to do. In the Task list, overdue tasks are displayed in red. When you tap a task in the Task list, a summary screen of the information you entered is displayed.

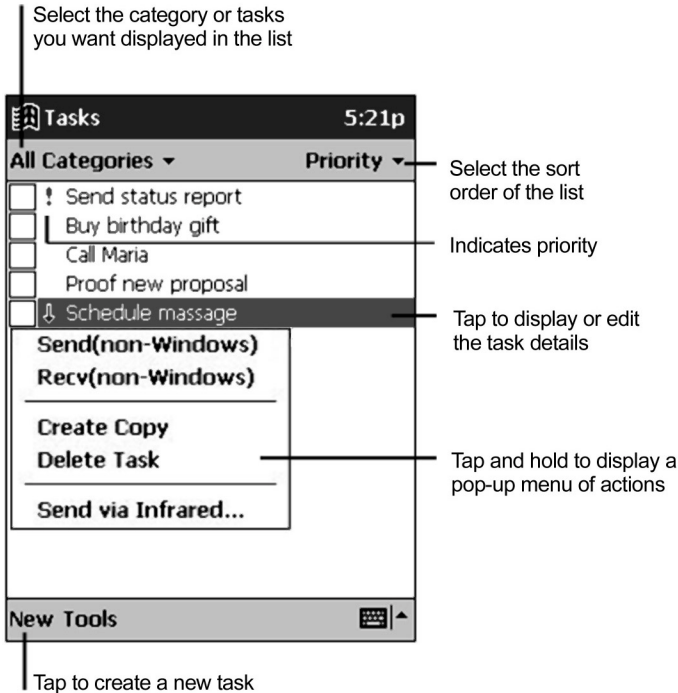

### The Task list

To change the way information is displayed in the list, tap **Tools** and then **Options**.



#### To create a task

1. Tap **New**.
2. Using the Input panel, enter a subject.
3. You can enter a start date and due date or enter other information by first tapping the field. If the Input panel is open, you will need to hide it to see all available fields.

4. To assign the task to a category, tap **Categories**, and then select a category from the list. (In the Task list, you can display tasks by category.)
5. To add notes, tap the **Notes** tab. You can enter text, draw, or create a recording. For more information on creating notes, see "Notes: capturing thoughts and ideas" later in this chapter.
6. When finished, tap **OK** to return to the Task list.



To quickly create a task with only a subject, tap **Entry Bar** on the **Tools** menu. Then, tap **Tap here to add a new task** and enter your task information.

## Notes: capturing thoughts and ideas

Quickly capture thoughts, reminders, ideas, drawings, and phone numbers with Notes. You can create a written note or a recording. You can also include a recording within a note. If a note is open when you create the recording, it will be included in the note as an icon. If the note list is displayed, the recording will be created as a standalone recording.

The screenshot shows the Notes application interface. At the top, it displays 'Notes' and the time '12:53p'. Below this is a list of folders: 'All Folders', 'Business1', 'Outlook Notes1', 'Personal1', and 'Team meeting notes'. A context menu is open over the 'Team meeting notes' folder, listing actions: 'Create Copy', 'Delete', 'Select All', 'Send via E-mail...', 'Send via Infrared...', and 'Rename/Move...'. At the bottom, there is a 'New Tools' bar with a recording toolbar and a keyboard icon.

Callouts and their descriptions:

- Tap to change the sort order of the list
- Tap to open a note or play a recording
- Tap and hold to display a pop-up menu of actions
- Tap to record
- Tap to show or hide the Recording toolbar
- Tap to create a new item

### The Notes list

### To create a note

1. Tap **New**.
2. Create your note by writing, drawing, typing, and/or recording. For more information about using the Input panel, writing and drawing on the screen, and creating recordings, see “Entering information” in chapter 2.

## Exchanging appointments, contacts, tasks, and notes with other devices (HP info exchange)

HP info exchange allows you to send and receive PIM data to and from non-Windows-powered PDA devices (for example, Palm devices) from within Calendar, Contacts, and Tasks via infrared. You can also receive (but not send) memos from a PDA device and store them as text files in the My Documents folder of your HP Jornada.

When you receive an item from a PDA device, it does not matter which Pocket Outlook application is active when you select **Recv(non-Windows)**. For example, you can have Contacts open and still receive a Calendar or Task item. (HP info exchange is not available in Pocket Outlook Inbox.)

---

HP info exchange runs only on your HP Jornada. No additional software is required for IrDA-equipped PDA devices.

---



### To send PIM information from your HP Jornada to an IrDA-equipped PDA device

1. In Contacts, Calendar, Tasks, tap to select the item you want to send.
2. Make sure the PDA device is powered on. Align the infrared port on your HP Jornada with the infrared port on the receiving device.
3. Tap **Send(non-Windows)** on the **Tools** menu of a PIM application on your HP Jornada. The HP info exchange Send window will appear, indicating that your HP Jornada is looking for a receiving device.

The PDA device will receive the transmitted items automatically.

---

You cannot send notes from your HP Jornada to a non-Windows-powered device by infrared.

---



### To receive PIM information on your HP Jornada from an IrDA-equipped PDA device

1. Set the PDA device to beam selected item(s).
2. Align the infrared port on your HP Jornada with the infrared port on the sending device.
3. Select **Recv(non-Windows)** on the **Tools** menu of a PIM application on your HP Jornada. The HP info exchange Receive window will appear indicating that your HP Jornada is looking for a sending device.

## About the data being transferred

HP info exchange makes it easy to exchange essential information with an IrDA-equipped PDA device. The data fields of your HP Jornada Contacts, Calendar, and Tasks applications are mapped to the data fields on the PDA device to allow capture of important PIM information. However, not all of the data fields correspond between the two devices, so not all data can be exchanged. Some notes on the features and characteristics of the field mappings for exchanged data are listed below:

- HP info exchange supports sending and receiving multiple contacts, appointments and tasks.
  - A number of Pocket Outlook fields are not used (e.g. Children, Spouse), because they are not used by other PDA devices or are not supported by the v-card standard.
  - If the number of entries of important field types (e.g. phone numbers) received exceeds the number of Pocket Outlook fields available to store them, the extra entries will be placed in the Notes section of the item.
  - For standard Contact fields (which support only single-line text), multiline text on PDA devices is converted into single-line text, and all CR/LF pairs converted to spaces. All information is retained.
  - Your HP Jornada treats Business Cards received from a PDA device as contacts.
  - Contents marked as "private" in other PDA devices are not sent to your HP Jornada.
  - Memos received from a PDA device are stored as text files in the My Documents folder of your HP Jornada. The received memos may be renamed so that no existing memos in your HP Jornada will be overwritten. (You cannot send a memo from your HP Jornada to a PDA device.)
-

# 7 | Companion programs

Your HP Jornada includes Microsoft Windows for Pocket PC, as well as programs from other vendors. The Pocket PC software includes Microsoft Pocket Word, Microsoft Pocket Excel, Microsoft Windows Media Player for Pocket PC, and Microsoft Reader. Third-party programs include OmniSolve from Landware. This section provides an overview of these programs and enough information to get you started. For complete instructions on using a program, refer to online Help for that program.

In this chapter you will learn about

- Microsoft Pocket Word
  - Microsoft Pocket Excel
  - Microsoft Windows Media Player for Pocket PC, MusicMatch Jukebox, and Windows Media Manager
  - Microsoft Reader
  - Landware OmniSolve financial calculator
-

## Microsoft Pocket Word

Microsoft Pocket Word works with Microsoft Word on your desktop PC to give you easy access to copies of your documents. You can create new documents on your HP Jornada, or you can copy documents from your desktop PC to your HP Jornada. Synchronize documents between your desktop PC and your HP Jornada regularly so that you have the most up-to-date content in both locations.

### To use Pocket Word

1. On the **Start** menu, tap **Programs**, and then tap the Pocket Word icon.
2. Tap the name of a document in the file list.  
—or—  
Tap **New** to open a blank document.



To open a template rather than a blank document, select a template for new documents. On the **Tools** menu, tap **Options**, and then browse to select the default template. When you tap **New**, the template appears with appropriate text and formatting already provided.

You can open only one document at a time; when you open a second document, you will be asked to save the first. You can save a document you create or edit in a variety of formats, including Pocket Word (.psw), Rich Text Format (.rtf), and Plain Text (.txt).

You can enter information in Pocket Word in four modes: writing, drawing, typing, and recording. Use the **View** menu to switch between modes. Each mode has its own toolbar, which you can show and hide by tapping the Show/Hide Toolbar button on the Command bar.

- **Typing Mode.** Use the Input panel to enter typed text into the document with either the soft keyboard or the Character Recognizer. For more information on entering typed text, see “Entering information” in chapter 2.
- **Writing Mode.** In writing mode, use your stylus to write directly on the screen. Ruled lines are displayed as a guide, and the zoom magnification is greater than in typing mode to allow you to write more easily. For more information on writing and selecting writing, see “Entering information” in chapter 2.



Written words are converted to graphics (metafiles) when a Pocket Word document is converted to a Word document on your desktop PC.



- **Drawing mode.** In drawing mode, use your stylus to draw on the screen. Gridlines appear as a guide. When you lift your stylus off the screen after the first stroke, you will see a drawing box indicating the boundaries of the drawing. Every subsequent stroke within or touching the drawing box becomes part of the drawing. For more information on drawing and selecting drawings, see “Entering information” in chapter 2.
- **Recording mode.** Use recording mode to embed a recording into your document. Recordings are saved as .wav files. For more information on recording, see “Entering information” in chapter 2.

## Tips for working in Pocket Word

- You can change the zoom magnification by tapping **View** and then **Zoom**. Then select the percentage you want. Select a higher percentage to enter text and a lower one to see more of your document.
- If you are opening a Word document created on a desktop PC, select **Wrap to Window** on the **View** menu so that you can see the entire document.

## Microsoft Pocket Excel

Microsoft Pocket Excel works with Microsoft Excel on your desktop PC to give you easy access to copies of your workbooks. You can create new workbooks on your device, or you can copy workbooks from your desktop PC to your device. Synchronize workbooks between your desktop PC and your device so that you have the most up-to-date content in both locations. Pocket Excel provides fundamental spreadsheet tools, such as formulas, functions, sorting, and filtering, which enable you to create simple workbooks such as expense reports and mileage logs.

### To use Pocket Excel

1. On the **Start** menu, tap **Programs**, and then tap the Pocket Excel icon.
2. Tap the name of a workbook in the file list.  
–or–  
Tap **New** to open a blank workbook.

---

To open a template rather than a blank workbook, select a template for new workbooks. On the **Tools** menu, tap **Options**, and then browse to select the default template. When you tap **New**, the template appears with appropriate text and formatting already provided.

---



You can open only one workbook at a time; when you open a second workbook, you will be asked to save the first. You can save a workbook you create or edit in a variety of formats, including Pocket Excel (.pxl) and Excel (.xls).

## Tips for working in Pocket Excel

- Use full-screen mode to see as much of your worksheet as possible. Tap **View** and then **Full Screen**. To exit full-screen mode, tap **Restore**.
- If your workbook contains sensitive information, you can protect it with a password. To do so, open the workbook, tap **Edit**, and then **Password**.
- Show and hide window elements. Tap **View** and then tap the elements you want to show or hide.
- Freeze panes on a worksheet. First select the cell where you want to freeze panes. Tap **View** and then **Freeze Panes**. You might want to freeze the top and leftmost panes in a worksheet to keep row and column labels visible as you scroll through a sheet.
- Split panes to view different areas of a large worksheet. Tap **View** and then **Split**. Then drag the split bar to where you want it. To remove the split, tap **View** and then **Remove Split**.
- Show and hide rows and columns. To hide a row or column, select a cell in the row or column you want to hide. Then tap **Format**, then **Row** or **Column**, and then **Hide**. To show a hidden row or column, tap **Tools**, then **Go To**, and then type a reference that is in the hidden row or column. Then tap **Format**, then **Row** or **Column**, and then **Unhide**.

## Microsoft Windows Media Player

Use Microsoft Windows Media Player for Pocket PC to listen to digital audio files, such as songs or sound clips. Media Player supports sound files recorded in the following formats: WMA, MP3, and WAV.

### To switch to Windows Media Player

1. On the **Start** menu, tap **Programs**, and then tap the Windows Media Player icon.
-

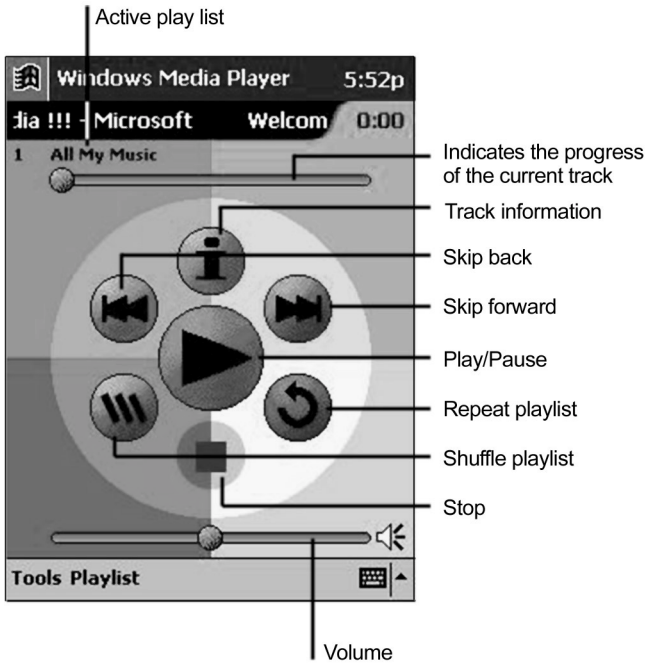

### The Windows Media Player Welcome screen

To save power, turn off the display while listening to music on your HP Jornada. Press and hold the Tasks hot key to turn the display off (without turning off the device). Press the Tasks hot key (when device is off) to turn the display on again.



## Creating audio files for your HP Jornada

You can copy music files to enjoy on your HP Jornada by converting or "ripping" files from your favorite audio CDs or by downloading songs from a Web site such as EMusic.com. When you have saved the audio file on your desktop PC, use the Microsoft Windows Media Manager for Pocket PC to convert the file to the appropriate format and copy it to your HP Jornada.

### Copying songs from audio CDs

Use the MusicMatch Jukebox application to record songs from your favorite audio CDs in a format that can be played on your HP Jornada. MusicMatch Jukebox is included on the HP Jornada CD-ROM.

## To copy a song from an audio CD

1. Install MusicMatch Jukebox from the HP Jornada CD-ROM onto your desktop PC. For more information, refer to the HP Jornada CD-ROM.
2. On your desktop PC, start the Jukebox program.
3. Insert an audio CD into the CD-ROM drive on your desktop PC. Jukebox should automatically detect the audio CD.
4. In the Jukebox window, select the song that you want to copy.
5. Enter the name of the song, the album title, and the artist's name.
6. Click the Play button (triangular arrow) to begin copying.
7. To specify the location of the song file, click **Recorder** on the **Options** menu, click **Settings**, and then select a folder.

## Using Microsoft Windows Media Manager for Pocket PC

Use Microsoft Windows Media Manager for Pocket PC on your desktop PC to create digital audio files in Windows Media format and to transfer audio files to your HP Jornada. Files saved in Windows Media use very little storage memory compared to some other recording formats.

Windows Media Manager is included in the Extras folder on the ActiveSync CD-ROM. You must install Windows Media Manager on your desktop PC to copy and convert digital audio files.



Some vendors distribute audio files as “packaged content”; that is, digital music that has been encrypted to protect the copyright. You must have a valid license to play packaged content on your HP Jornada. For more information about obtaining a license and specific license terms, read the license agreement provided by the file vendor.

---

## Using the Playlist Manager

Use the Playlist Manager to set the track playback order. **All My Music** is the default playlist. It contains all digital audio files available for playback on your HP Jornada (including those stored on a CompactFlash card, if one is installed). To see a list of recently selected playlists, tap **Select Playlist**. To create or edit playlists, tap **All Playlists**.

Tap and hold a track or playlist to perform actions such as copying, moving, and deleting.

---

## Working with audio files on a CompactFlash Card

Because songs and audio files can use a lot of storage memory, you might want to store them on a Type I CompactFlash card. When you store songs and audio files on a Type I CompactFlash card, the files must be stored in a folder named My Documents. In addition, it is recommended that you use Microsoft Windows Media Manager for Pocket PC to transfer files from your desktop PC to the storage card, because Media Manager can automatically resolve security protocols for packaged content. For more information on installing a CompactFlash card and working with files on a storage card, see “CompactFlash cards” in chapter 8.

---

When you store songs and audio files on a CompactFlash card, the files must be stored in a folder named My Documents.

---



## Microsoft Reader

Use Microsoft Reader to read electronic books (eBooks) on your HP Jornada. Download books to your desktop PC from eBook Web sites. Then, use ActiveSync to copy the book files to your Pocket PC. The books appear in the Reader Library.

An eBook includes many features not available with a paper book. These features are available from any book page. You can add notes or bookmarks, highlight text, search for words or phrases, and copy text to use in other documents or messages.

The Reader Guidebook is preinstalled on your HP Jornada, and contains all the information you will need to use Microsoft Reader. Open the Guidebook from within Microsoft Reader, as described below.

### To start Microsoft Reader

1. On the **Start** menu, tap **Programs**, and then tap **Microsoft Reader**. Microsoft Reader displays the Library, a list of all the eBooks stored on your HP Jornada.
2. To open a book, tap the title in the Library list.

The MSReader folder in the Extras folder on the ActiveSync CD-ROM contains sample books and a dictionary. Use ActiveSync to download the files from your desktop PC to your device as described in the Readme file in the MSReader folder.

---



When you have finished reading a book, you may want to delete it to conserve space on your device. If a copy of the book is stored on your desktop PC, you can download it again at any time. To remove a book from your device, tap and hold the title in the Library list and then tap **Delete** on the pop-up menu.

---

## OmniSolve

OmniSolve is a financial application that is designed specifically for real estate, retail, and business professionals who use Pocket PCs to make financial decisions quickly and accurately. OmniSolve employs a form-filling metaphor to provide a rich problem-solving environment that is unparalleled in ease of use, power, and flexibility.

### To start OmniSolve

1. On the **Start** menu, tap **Programs**, and then tap the OmniSolve icon.

For detailed help and procedures about using OmniSolve, refer to online Help or see the LandWare Web site at [www.landware.com/omnisolve](http://www.landware.com/omnisolve).



For other non-HP Pocket PC software solutions, refer to the HP Jornada CD-ROM or visit the HP Jornada Web site at [www.hp.com/jornada/solutions](http://www.hp.com/jornada/solutions)

---

## 8 | Accessories

By purchasing accessories for your HP Jornada, you can add functionality, replace lost parts, and protect your Pocket PC from accidental damage. HP makes a variety of accessories designed specifically to enhance your HP Jornada Pocket PC. In addition, you can purchase CompactFlash card accessories from many vendors. This chapter describes

- accessories available from HP
- how to install and use CompactFlash cards



## HP branded accessories

The following optional accessories are available from Hewlett-Packard. (HP item numbers are listed in parentheses.) Check the Hewlett-Packard Web site at [www.hp.com/jornada/accessories](http://www.hp.com/jornada/accessories) for updates to this list. These accessories work with all models of the HP Jornada 520 Series Pocket PC.

- **Serial Cradle (F1834A).** Connect your HP Jornada to a serial communications port on a desktop PC using this desktop cradle.
  - **Serial Cable (F1819A).** Connect your HP Jornada to a serial communications port on a desktop PC.
  - **AC Adapter (F1817A).** Connect to ac power anywhere in the world with this worldwide voltage adapter.
  - **Executive Leather Case (F1829A).** Protect your HP Jornada in style with this slim, executive design leather case with stylus holder. Flip-top design allows for maximum ergonomic fit and functionality.
  - **Executive Bi-Fold Leather Case (F1826A).** Protect your HP Jornada with this elegantly designed bifold leather case for classical look and functionality.
  - **Leather Clip Pouch in Brown (F1887A) or Black (F1886A).** Keep your HP Jornada at your side with a clip-on belt pouch.
  - **Stylus Pens (F1818A).** Replace your lost stylus with this pack of three original pens.
  - **Color Cover (F1850A).** Protect your HP Jornada in style with a colorful metal cover with built-in stylus slot.
  - **Screen Protectors (F1827A).** Protect your touch screen from scratches and scuffs with a plastic screen protector (pack of six).
-



## CompactFlash cards

CompactFlash cards provide a wide range of additional functionality, such as additional memory, removable storage, connection to an external monitor, connection to a network, and modems.\* Many cards have been tested specifically for use with the HP Jornada. For a list of recommended cards, visit the HP Web site at [www.hp.com/jornada/accessories](http://www.hp.com/jornada/accessories).

Before you can use a particular card, you may need to install the software driver for that card. The software drivers for the Windows for Pocket PC operating system should be available from the card's manufacturer. Install software drivers as you would install any other software or program. For more information, see "Adding or removing programs" in chapter 5.

### To install a CompactFlash card

1. Open the door to the CompactFlash slot.
2. Insert the CompactFlash card into the slot.

If you are using a CompactFlash memory card or another card that does not require a cable, you can close the door to the CompactFlash slot while the card is installed in your HP Jornada.

If you are using a CompactFlash Card modem or NIC, which requires a cable connection to the card, the cable connector will protrude from the slot, and you cannot close the door. Slide the door into the casing of the device parallel to the CompactFlash card until it is recessed inside your HP Jornada.

---

\* Modem must be purchased separately. Some Web sites/content may not be available.

---



**The Type I CompactFlash card slot.**

# 9 | Troubleshooting

If you encounter difficulty while using your HP Jornada Pocket PC, this chapter will help you find answers. If you need information about troubleshooting ActiveSync, click **Microsoft ActiveSync Help** on the **Help** menu in ActiveSync.

The information in this chapter will help you

- Reset your HP Jornada.
  - Restore your HP Jornada to the factory default settings.
  - Troubleshoot basic problems.
  - Troubleshoot problems with remote connections.
  - Troubleshoot problems with the display and touch screen.
-

## Resetting your HP Jornada

Occasionally, you may need to reset your HP Jornada; for example, you may reset after you restore data from your desktop PC or when the operating system stops responding. Resetting your HP Jornada is similar to restarting your desktop PC. It restarts the operating system and preserves any saved data, but you will lose any unsaved data. Some user-configurable HP settings may not be saved when you reset your HP Jornada.

Reset after restoring data from a backup file or when the HP Jornada appears to be “frozen” or “locked up.”

---



When you reset, you lose unsaved data in all open documents or programs. Use HP task switcher to close all open documents and programs. (In the Today screen, tap the HP task switcher icon, and then tap **Close Window** and **Close All** on the pop-up menu.)

---

### To reset

1. Disconnect the sync cable or remove your HP Jornada from the serial cradle.\*
2. Remove the CompactFlash card (if installed).
3. Use the stylus to press the Reset button on the back of the HP Jornada, as shown in the following illustration.

---

\* Serial cradle can be purchased as an optional accessory.

---



**The Reset button**

## Restoring factory defaults

In some cases, such as when your HP Jornada does not respond after being reset or when you forget your password, you may need to restore your HP Jornada to the factory default settings. This erases all data you have entered, including all files, system settings, and programs you have installed.

To ensure the safety of your information should it be necessary to restore the factory defaults, you should regularly back up your data to your desktop PC (using ActiveSync) or to a CompactFlash card (using the HP backup application). For more information on backing up data, see “Backing up and restoring data” in chapter 3.

---

Restoring the factory default settings erases all files, programs, and data you have entered. You can restore only data that has been backed up to your desktop PC or CompactFlash card. (For more information, see “Backing up and restoring data” in chapter 3.)

---



## To restore the factory defaults

1. Disconnect your HP Jornada from ac power and disconnect it from your desktop PC.
2. Use the tip of the stylus to press and hold the Reset button on the back of your HP Jornada.
3. While holding the Reset button, press the On/Off button.
4. Release the Reset button.
5. Press the On/Off button again to restart your HP Jornada.

After you restore the factory defaults, you will need to complete the Welcome Wizard and re-establish a partnership with your desktop PC. You may also want to restore data to your HP Jornada from your most recent backup file. For more information, see "Using your HP Jornada for the first time" in chapter 2 and "Backing up and restoring data" in chapter 3.

## Basic problems

If you have a specific problem, review the information below to see if you can quickly find the answer. Or, visit the HP Web site at [www.hp.com/jornada](http://www.hp.com/jornada) for more information about common difficulties.

<b>Problem</b>	<b>Diagnosis/Remedy</b>
HP Jornada does not turn on when not connected to ac power.	<i>Power is too low to run your Pocket PC.</i> Connect to ac power, and then turn on your HP Jornada. (Charge the battery regularly to avoid running out of battery power.)
Battery runs out of power quickly.	<i>You are using your HP Jornada in ways that drain power quickly.</i> Use external power to charge and power your device whenever possible, especially when using a CompactFlash card that requires significant power (such as a modem card or NIC).  For more information, see "Managing power" in chapter 5.
HP Jornada does not auto-suspend when connected to a desktop PC.	<i>The HP Jornada is designed to stay on while connected to a computer.</i> This is the correct behavior. No action is needed.

Problem	Diagnosis/Remedy
<p>HP Jornada automatically shuts down/suspends.</p>	<p><i>Power is too low to run the Pocket PC.</i> When a critically low power condition is encountered, the HP Jornada initiates a safety shutdown. Connect to ac power and charge the battery.</p> <p>–or–</p> <p><i>Auto-suspend activated.</i> To conserve power, the HP Jornada auto-suspends if it is idle for 1 minute immediately after power is turned on. It also auto-suspends if it is continuously idle for 3 minutes.</p> <p>–or–</p> <p><i>HP Jornada is locked up.</i> Connect to external power, and reset your HP Jornada. (See “Resetting your HP Jornada” in this chapter.) (Caution: You may lose any unsaved data when resetting.)</p>
<p>HP Jornada locks up when running applications, or it runs slowly.</p>	<p><i>HP Jornada is locked up.</i> Connect to ac power, and reset. (See “Resetting your HP Jornada” in this chapter.) Note: Check to ensure that the device is not running low on power, and avoid running several applications at the same time. Use HP task switcher to close applications that are not in use.</p>
<p>HP Jornada does not turn on or display appears to be off, even though power is on.</p>	<p><i>The display contrast and brightness are too low.</i> Use HP settings to adjust contrast and brightness for optimal viewing. (Refer to “Adjusting settings” in chapter 5.)</p> <p>Use HP settings to choose <b>Outdoor</b> in very bright light and <b>Low Power</b> in very dark conditions. (Refer to “Adjusting settings” in chapter 5.)</p> <p>–or–</p> <p><i>The device has been reset.</i> After a reset, the screen remains blank for approximately 3 seconds after pressing the On/Off button.</p>

<b>Problem</b>	<b>Diagnosis/Remedy</b>
HP Jornada does not turn on or display appears to be off, even though power is on.	<i>HP Jornada has run out of power.</i> Charge the device by connecting to ac power
Backup file created with the HP backup application on another HP handheld device cannot be restored to the HP Jornada.	<i>Only PIM data can be migrated to HP Jornada 520 Series Pocket PCs.</i> Because the HP Jornada 520 Series Pocket PC uses a newer operating system, it is recommended that you restore PIM data from an older device by using Microsoft ActiveSync or Microsoft Outlook rather than HP backup. Synchronize your older HP handheld device with Microsoft Outlook on your desktop PC, and then establish a new partnership to transfer data to your new HP Jornada.
Difficult to install or run software from previous HP handheld on HP Jornada 520 Series.	<i>Software that runs on previous HP handheld devices may not run on your HP Jornada 520 Series Pocket PC.</i> Because the HP Jornada 520 Series Pocket PC uses a newer operating system, software built for previous-generation Windows CE for palm-sized PCs (such as HP Jornada 430/420) may not run on your HP Jornada 520 Series. Check with the software vendor for an upgrade or newer version that will run on the HP Jornada 520 Series.
Inaccurate response to stylus tap.	<i>The calibration of the touch screen may be off.</i> Realign the touch screen by pressing and holding the On/Off button to open the Align Screen control panel.
Cannot find or replace main or backup battery.	The HP Jornada 520 Series is designed with an integral high-performance rechargeable Li-ion battery for operation and data retention. You need only connect to external power to charge the battery for uninterrupted usage and data retention.



Problem	Diagnosis/Remedy
Cannot reset the factory default settings because there is no backup battery.	Refer to “Resetting your HP Jornada” in this chapter. Note that all data in device memory will be erased.
Unable to locate files in CompactFlash memory in applications.	<i>Files must be stored in the My Documents folder on the CompactFlash card.</i> Create the My Documents folder using File Explorer, and move files into this folder.
Data is lost.	<i>HP Jornada has run out of power.</i> Restore data from a backup file on your desktop PC or a CompactFlash card.  –or– <i>Factory default settings have been restored.</i> Restore data from a backup file on your desktop PC or a CompactFlash card.

## Remote connections

This section offers troubleshooting help for connecting your HP Jornada to other computers. For problems communicating with your desktop PC, see ActiveSync Help.

### Able to dial out, but unable to make proper connection

Make sure the network to which you are trying to connect supports Point-to-Point Protocol (PPP). Your ISP or network administrator can verify this.

Verify that the dialing location is correct. On the **Start** menu, tap **Settings**, and then tap **Connections**, **Modem**, **Dialing** to ensure the **Location** field reflects your current location.

### Modem connection is unreliable

Make sure the modem is firmly seated and connected to your device and the telephone jack.

Disable Call waiting. On the **Start** menu, tap **Settings**, and then tap the **Connections** tab. Tap the Modem icon, and then on the **Dialing** tab, select the **Disable call waiting** check box and enter the disable code specified by your telephone company.

## Unable to use infrared transfer between Windows-powered devices

If you are unable to use infrared to transfer information between Windows-powered devices, try the following:

- Transfer only one file, or no more than 25 contact cards, at a time.
- Position the infrared ports so that they line up and are less than 20 cm (8 inches) but more than 5 cm (2 inches) apart.
- Make sure nothing is between the two infrared ports.
- Adjust the room lighting. Some types of light interfere with infrared communication. Try moving to a different location or turning off some lights.

## Network connection problems



The following solutions may help if you encounter problems when using a network card for network connections. Additional troubleshooting information is available in Connections Help on the device and ActiveSync Help on the desktop PC.

- Verify that your NIC is compatible with the HP Jornada 520 Series Pocket PC.
  - Verify that you have added necessary server information. On the **Start** menu, tap **Settings**. On the **Connections** tab, tap **Network**. Tap your installed adapter (usually your Ethernet card's name) and enter any necessary information. Most networks use DHCP, so you should not have to change these settings unless your network administrator instructs you to do so.
  - If **Network Connection** is not listed as a connection method in the **ActiveSync** dialog box when starting synchronization, wait a few minutes and try again. Also, if synchronization does not start right away, the network is probably busy, and it may take a minute for your device to connect to the network.
  - Make sure that the proper drivers for your card are installed on the device. For more information, see the owner's manual for the network card.
  - Verify with your network administrator that your user name and password are correct.
  - Verify with your network administrator that the network you are trying to connect to is available, or try to connect to it from another computer.
-

- You may need to change the device name if you are trying to connect to a network and cannot because another device with the same name is already connected. To change the device name, on the **Start** menu, tap **Settings**. On the **System** tab, tap **About**, and then the **Device ID** tab.

## Cable and cradle connection problems

The following solutions may help if you encounter problems when connecting to your desktop PC. Additional troubleshooting information is available in Connections Help on your HP Jornada and ActiveSync Help on your desktop PC.

- Ensure the device is turned on.
- If a modem or Ethernet card is inserted into your device, remove it.
- Ensure that you do not have any other active connections. On the **Start** menu, tap **Today**. Tap  or  at the bottom of the screen and then tap **Disconnect**.
- Ensure the cable is securely plugged into the COM port on the back of your desktop PC. Use the cable that came with the device without any extra cables or extenders attached.
- Plug the other end of the cable securely into the correct port on your device. If you are using a cradle, push your device securely into the cradle.

## Display problems

If you are having trouble viewing data on your HP Jornada screen, follow these suggestions.

### Screen is blank

Follow these steps if the screen remains dark or if the device does not respond when you briefly press the On/Off button:

- Press the Tasks hot key to ensure that the display is on.
  - Adjust the display contrast and brightness. On some devices, the screen can be darkened or lightened until the device appears to be powered off. (Refer to “Adjusting settings” in chapter 5.)
  - Reset the device. After a reset, the screen remains blank for approximately 3 seconds after pressing On/Off buttons.
  - Charge the device by connecting to ac power.
-

## Screen is dark

Prolonged exposure to direct sunlight may cause your device screen to temporarily darken. This is normal for LCD screens and is not permanent.

## Display is difficult to see in sunlight or in dark rooms

Use HP settings to adjust contrast and brightness for optimal viewing. (Refer to "Adjusting settings" in chapter 5). In very bright light, select the **Outdoor** profile in HP settings. In very dark conditions, select the **Low Power** profile. In a dark room, you may also need to ensure that the backlight is on and/or position a lamp so that the light shines directly on the screen.

## Screen is hard to read

If you are having a hard time viewing a document in Notes, try changing the size of the view. To do this, tap a zoom percentage on the **Tools** menu. In Pocket Word and Pocket Excel, tap **Zoom** on the **View** menu and then select a zoom percentage. In Pocket Internet Explorer, tap **Text Size** on the **View** menu, and then select a size.

If you are having a hard time viewing Pocket Outlook data, try enlarging the display font. To do this within Calendar, Tasks, or Contacts, tap **Tools**, then **Options**, and then select **Use large font**.

---

# 10 | Support and service

## Web site

You can obtain product information as well as tips and hints on how to get more from the HP Jornada product at our Worldwide Web site. This computer service is provided free of charge; you pay only for telephone charges and Internet service fees. To connect to this Web site from a computer via the Internet, go to [www.hp.com/jornada](http://www.hp.com/jornada).

## Customer support

If you have questions that this User's Guide or the Web site does not answer (after checking the contents and index), you can contact Hewlett-Packard Worldwide Support and Services for Handheld Products at the telephone numbers listed in the following table.

If the device requires service, contact Hewlett-Packard for service information, shipping instructions, and out-of-warranty service charges before you send your device to HP for repair.

In countries not listed in the table, contact the Hewlett-Packard authorized dealer or sales office.

## Service

For diagnostic instructions and other service information, contact one of the technical support numbers listed. Please do not ship your device for service without first contacting a Hewlett-Packard office. If your device qualifies for in-warranty service, be ready to supply a dated proof of purchase. In countries not listed in the following table, contact the Hewlett-Packard authorized dealer or sales office.

Before you contact us for help, be sure to:

1. Review the manuals whenever possible.
  2. Have the following information about the product:
    - model number
    - serial number
    - purchase date
-

3. Have your product ready to use. The support personnel may ask you to run tests and other operations.
4. Organize your question or problem. The more detailed information you can provide, the quicker the support personnel can help you.

## Contacting Hewlett-Packard worldwide

You will be pleased to know that our commitment to quality does not stop at the sale. Our worldwide customer support network is available to give you personal telephone service should you need it.

<b>Country/Region</b>	<b>Telephone</b>
Argentina	
Buenos Aires	54-11-4778-8380
Rest of the country	0810-555-5520 ext. 4778/8380
Australia	
	61-3-88778000
Austria	
	43-711-4201080
Belgium (Dutch)	
	32-2-6268806
Belgium (French)	
	32-2-6268807
Brazil	
Sao Paulo	11-3747-7799
Rest of the country	0800-157751
Canada	
	1-905-2064663
Chile	
	56-800-360999
China	
	86-10-65645959
Czech Republic	
	420-2-61307310
Denmark	
	45-39-294099
Finland	
	358-20347288
France	
	33-1-43623434
Germany	
	49-1-805258143
Greece	
	30-1-6896411
Hong Kong	
	800-967729

<b>Country/Region</b>	<b>Telephone</b>
Hungary	36-1-3430310
India	91-11-6826035
Indonesia	62-21-3503408
Ireland	353-1-6625525
Israel	972-9-9524848
Italy	39-2-26410350
Japan	81-3-33358333
Korea	82-2-32700700
Malaysia	60-03-2952566
Mexico	
Mexico City	52-58-9922
Rest of the country	01-800-4720684
Netherlands	31-20-6068751
New Zealand	64-9-3566640
Norway	47-22-116299
Philippines	63-2-8673551
Poland	48-22-8659999
Portugal	351-13180065
Russia	7-095-9169821
Singapore	65-2725300
South Africa	27-11-8061030
Spain	34-91-7820109
Sweden	46-8-6192170
Switzerland (German)	41-1-4332728
Switzerland (French)	41-1-4332729
Taiwan	886-2-27170055
Thailand	66-2-6614000

---

<b>Country/Region</b>	<b>Telephone</b>
Turkey	90-212-2245925
UK	44-870-6083003
USA	
Pre-sales Information	1-800-4431254 (toll-free, no operator is available)
Support & Service	1-970-635-1000 Palmtops & Organizers (toll call)
Venezuela	
Caracas	207-8488
Rest of the country	800-47-777
Vietnam	84-0-88234530

All Customer Care Centers are available during office hours. Pre-sales Information in the USA is available 24 hours per day, 7 days per week. Support & Service in the USA can be contacted from 5 am to 5 pm Pacific Time, Monday through Friday.



# Warranty

**Important:** This is your hardware product warranty statement. Read it carefully.

Warranty terms may be different in your country. If so, your Authorized HP Dealer or Hewlett-Packard Sales and Service office can give you details.

## One year limited hardware warranty

Hewlett-Packard (HP) warrants this hardware product against defects in material and workmanship for a period of one year from receipt by the original end-user purchaser.

If HP receives notice of the above-defined defects during the warranty period, HP will either, at its option, repair or replace products that prove to be defective.

Should HP be unable to repair or replace the product within a reasonable amount of time, the customer's alternate exclusive remedy shall be a refund of the purchase price upon return of the product.

## Limitation of warranty

The above warranty shall not apply to defects resulting from: misuse; dropping the unit; unauthorized modification; opening for any reason except to perform an official upgrade using an HP Upgrade Kit; operation or storage outside the environmental specifications for the product; in-transit damage; improper maintenance; or defect resulting from use of non-HP software, accessories, media, supplies, consumables, or such items not designed for use with the product.

HP makes no other express warranty, whether written or oral, with respect to this product.

Any implied warranty of merchantability or fitness for a particular purpose is limited to the one-year duration of this written warranty.

Some states, provinces, or countries do not allow limitations on how long an implied warranty lasts, so the above limitation or exclusion may not apply to you.

---

This warranty gives your specific legal rights, and you may also have other rights that vary from state to state, province to province, or country to country.

## **Limitation of liability and remedies**

The remedies provided above are the customer's sole and exclusive remedies.

In no event shall HP be liable for any direct, indirect, special, incidental, or consequential damages (including lost profit), whether based on warranty, contract, tort, or any other legal theory.

Some states, provinces, or countries do not allow the exclusion or limitation of incidental or consequential damages—including lost profit—so the above limitation or exclusion may not apply to you.

## **Consumer transactions in Australia, New Zealand and the United Kingdom**

The preceding disclaimers and limitations shall not apply to consumer transactions in Australia, New Zealand and the United Kingdom, and shall not affect the statutory rights of consumers.

### **For consumers in Australia**

The above warranty terms and any other warranty statement enclosed with this product, except to the extent lawfully permitted, do not exclude, restrict, or modify and are in addition to the statutory rights implied by the Trade Practices Act 1974 or any corresponding State or territory legislation applicable to the sale of this product to you. If you have any queries about your rights, contact the Hewlett-Packard Customer Care Center at 61-3-88778000.

### **For consumers in New Zealand**

The above warranty terms or any other warranty statement enclosed with this product, except to the extent lawfully permitted, do not exclude, restrict or modify and are in addition to the statutory rights implied by the Consumer Guarantees Act 1993 applicable to the sale of this product to you. If you have any queries about your rights contact the Hewlett-Packard End User Support line at 0800-733547.

---

# HP software product license agreement and HP software product limited warranty

This HP product contains preinstalled software programs. Please read the HP Software Product License Agreement before proceeding.

**Important:** Carefully read this License Agreement and the Limited Warranty statement before operating the equipment. The rights to the software are licensed, not sold. HP or its licensors continue to own all intellectual property rights to the software, and you will be granted certain rights to use the software upon your acceptance of this license. Rights in the software are offered only on the condition that you agree to all terms and conditions of the License Agreement. Operating the equipment indicates your acceptance of these terms and conditions. If you do not agree to the terms and conditions of the License Agreement, return the complete package for a full refund now.

## HP Software Product License Agreement

The HP Software Product License Agreement shall govern the use of all software that is provided to you, the customer, as part of this HP product with the exception of Microsoft Software. Microsoft Products are licensed to you under the Microsoft End User License Agreement (EULA) contained in the Microsoft documentation. Any third-party software supplier's warranty terms that may be found online, or in any documentation or other materials contained in the product packaging, shall govern the use of that third-party software.

The following License Terms govern the use of the software:

### Use

You may only use the software on a single computer. You may not reverse, assemble, or decompile the software.

Transaction in European Union member states: The prohibition against decompilation shall be subject to Directive 91/250/EEC.

### Copies and adaptations

You may make copies or adaptations of the software (a) for archival purposes, or (b) when copying or adaptation is an essential step in the use of the software with a computer so long as the copies and adaptations are used in no other manner.

You have no other rights to copy unless you acquire an appropriate license to reproduce which is available from HP for some software.

---

You agree that no warranty, free installation, or free training is provided by HP for any copies or adaptations made by you.

All copies and adaptations of the software must bear the copyright notice(s) contained in or on the original.

### **Ownership**

You agree that you do not have any title to or ownership of the software, other than ownership of the physical media. You acknowledge and agree that the software is copyrighted and protected under the copyright laws. You acknowledge and agree that the software or part thereof may have been developed by a third-party software supplier named in the copyright notice(s) included with the software, who shall be authorized to hold you responsible for any copyright infringement or violation of this or their own License Agreement.

### **Transfer of rights in software**

You may transfer rights to the software to a third party only as part of the transfer of all your rights and only if you obtain the prior agreement of the third party to be bound by the terms of this License Agreement. Upon such a transfer, you agree that your rights to the software are terminated and that you will either destroy all your copies and adaptations or deliver them to the third party. Transfer to a U.S. government department or agency or to a prime or lower tier contractor in connection with a U.S. government contract shall be made only upon prior written agreement to terms required by HP.

### **Sublicensing and distribution**

You may not lease, sublicense the software, or distribute copies or adaptations of the software to the public in physical media, by telecommunication or at all without the prior written consent of HP.

### **Termination**

HP may terminate this software license for failure to comply with any of these terms, provided HP has requested you to cure the failure and you have failed to do so within thirty (30) days of such notice.

### **Updates and upgrades**

You agree that the software does not include updates and upgrades that may be available from HP under a separate support agreement.

### **Export clause**

You agree not to export or re-export the software or any copy or adaptation in violation of the U.S. Export Administration regulations or other applicable regulations.

---

### **U.S. government restricted rights**

The Software and Documentation have been developed entirely at private expense. They are delivered and licensed as “commercial computer software” as defined in DFARS 252.227-7013 (Oct 1988), DFARS 252.211-7015 (May 1991) or DFARS 252.227- 7014 (Jun 1995), as “commercial item” as defined in FAR 2.101 (a), or as “Restricted computer software” as defined in FAR 52.227-19 (Jun 1987) (or any equivalent agency regulation or contract clause), whichever is applicable. You have only those rights provided for such Software and Documentation by the applicable FAR or DFARS clause or the HP standard software agreement for the product involved.

## **HP Software Product Limited Warranty**

Important: This HP Software Product Limited Warranty shall cover all software that is provided to you, the customer, as part of the HP product, including any operating system software. Any third-party software supplier's warranty terms that may be found on-line, or in any documentation or other materials contained in the product packaging shall supersede the HP Software Product Limited Warranty with regard to that third-party software.

### **Ninety-Day Limited Software Warranty**

HP warrants for a period of NINETY (90) DAYS from the date of purchase that the software product will execute its programming instructions when all files are properly installed. HP does not warrant that the software will be uninterrupted or error free. In the event that this software product fails to execute its programming instructions during the warranty period, your remedy shall be replacement or refund only. Return the media to HP for replacement. Should HP be unable to replace the media within a reasonable amount of time, HP shall refund the purchase price upon return of the product and all copies.

### **Removable media (if supplied)**

HP warrants the removable media, if supplied, upon which this product is recorded to be free from defects in material and workmanship under normal use for a period of NINETY (90) DAYS from the date of purchase. In the event the media proves to be defective during the warranty period, your remedy shall be replacement or refund only. Return the media to HP for replacement. Should HP be unable to replace the media within a reasonable amount of time, HP shall refund the purchase price upon return of the product and destruction of all other non-removable media copies of the software product.

---

### **Notice of warranty claims**

You must notify HP in writing of any warranty claim not later than thirty (30) days after the expiration of the warranty period.

### **Limitation of warranty**

HP makes no other express warranty, whether written or oral, with respect to this product.

Any implied warranty of merchantability or fitness for a particular purpose is limited to the 90-day duration of this written warranty. Some states, provinces, or countries do not allow limitations on how long an implied warranty lasts, so the above limitation or exclusion may not apply to you. This warranty gives specific legal rights, and you may also have other rights that vary from state to state, province to province, or country to country.

### **Limitation of liability and remedies**

THE REMEDIES PROVIDED ABOVE ARE YOUR SOLE AND EXCLUSIVE REMEDIES. IN NO EVENT SHALL HP BE LIABLE FOR ANY DIRECT, INDIRECT, SPECIAL, INCIDENTAL, OR CONSEQUENTIAL DAMAGES (INCLUDING LOST PROFIT), WHETHER BASED ON WARRANTY, CONTRACT, TORT, OR ANY OTHER LEGAL THEORY. Some states, provinces, or countries do not allow the exclusion or limitation of incidental or consequential damages—including lost profit—so the above limitation or exclusion may not apply to you.

In no case shall HP's liability exceed the purchase price for the software and/or product. The limitations set forth above will apply regardless of whether you accept the software.

Consumer transactions in Australia and the United Kingdom: The disclaimers and limitations above shall not apply and shall not affect the statutory rights of a Consumer.

---

# Glossary

**AC adapter.** An external power supply that converts ac power from a standard household electrical outlet to the low-voltage dc required to operate your HP Jornada.

**Backup.** A duplicate copy of your HP Jornada files and data that is stored on your desktop PC or on a PC card.

**CompactFlash.** A removable media for high-performance memory cards and other peripherals such as modems and network interface cards.

**Cradle.** A desktop base for your HP Jornada that allows instant connectivity to a desktop PC. The cradle remains connected to your desktop PC, even when you remove your HP Jornada.

**Dial-up connection.** A connection between your HP Jornada and another computer by modem. You can have a dial-up connection with an ISP, a network, or with a modem attached to a PC.

**Direct connection.** A connection between your HP Jornada and another computer by means of the sync cable or IR port.

**DNS (Domain Name System).** An Internet service that translates domain names into IP addresses. For example, the domain name `www.jornada.com` might translate as `198.125.247.4`.

**Driver.** A control program that enables a computer to work with a specific device or peripheral.

**IMAP4 (Internet Messaging Access Protocol v4).** A protocol that enables a computer to retrieve messages from a mail server.

**Infrared port.** A communication port that uses optical (infrared) signals rather than wires or cables to transmit data.

**Internet.** A worldwide network of computers offering services such as e-mail, the Worldwide Web, FTP, Usenet news, and others.

**Intranet.** A network that offers services similar to the Internet, but is usually accessible only to users within a single company or organization.

**IP (Internet Protocol).** The standard by which packets of information are transmitted over the Internet.

---

**IrDA (Infrared Data Association protocol).** An established standard for infrared communications between computers and other peripherals and devices.

**ISP (Internet service provider).** A commercial business that provides Internet access to individuals or businesses, usually for a fee.

**LAN (local area network).** A group of computers, usually in close proximity (either in the same building or in buildings in close proximity), that are linked together to share files and exchange data.

**Modem.** A communication device that enables a computer to transmit data over telephone lines.

**NIC (network interface card).** A network interface card (NIC) is a card that is installed in a computer so that it can be connected to a network. Network interface cards can provide a dedicated, full-time connection to a network.

**Partnership.** An established relationship between your HP Jornada and your PC for the purpose of synchronizing and transferring data.

**PIM (personal information manager).** An application or set of applications that organizes information such as addresses, appointments, and notes.

**POP3 (Post Office Protocol v3).** A protocol that enables a computer to retrieve messages from a mail server.

**PPP (Point-to-Point Protocol).** The default method your HP Jornada uses to communicate with an ISP network server.

**Proxy server.** A server that sits between a client computer or Web browser and the Internet. A proxy server provides security by filtering requests and can improve performance by storing local copies of requested information.

**RAM (random access memory).** Volatile memory that be read and written. Data stored in RAM is retained only while power is maintained.

**Remote connection** A connection between your HP Jornada and a remote computer or server.

**Reset.** The process of restarting your HP Jornada and reinitializing the operating system. Performing a reset erases any unsaved data in open documents, but preserves data that has been saved.

**Restore.** To return your device to the state it was in when it was last backed up. This involves copying your backup data to your HP Jornada.

**ROM (read-only memory).** A memory circuit into which programs and data are permanently installed. Data in ROM cannot be modified or deleted.

---



**Serial connection.** A cable connection between your HP Jornada and a serial (COM) port on your desktop PC.

**SLIP (Serial Line Internet Protocol).** A method of connecting to the Internet. Similar to PPP, but older and simpler.

**SMTP (Simplified Mail Transport Protocol).** A protocol for sending e-mail messages between computers on the Internet.

**Stylus.** A pen-like utensil designed for navigating on a touch screen.

**Synchronization.** The process of comparing the files or data on two computers to ensure that they contain the exact same information.

**Touch screen.** A touch-sensitive screen that allows you to open files, launch programs, and select text by touching or tapping the screen with the stylus.

---



# Appendix A

## Character recognition

Using Character Recognizer, you can write characters directly on your HP Jornada screen with your stylus, just as you would on a piece of paper. The characters you write are translated into typed text. Use Character Recognizer anywhere you want to enter text; for example, to write a note or to fill in fields in a dialog box.

The default writing mode for Character Recognizer is lowercase (Jot-compatible) mode. In this mode, you write characters in lowercase. The chart at the end of this appendix contains examples of how to write characters in lowercase mode. You can also choose to write in uppercase (Graffiti-compatible) mode. In this mode, you write characters in uppercase. If you prefer to write in uppercase mode, tap **Uppercase Mode** in **Options** on the input method menu. Whether a letter appears in uppercase or lowercase when it is converted to typed text depends on where in the Input panel you write it, not on the mode you have selected.

The Character Recognizer Input panel is divided into three writing areas. Letters written in the left area (labeled **ABC**) create uppercase letters, and letters written in the middle area (labeled **abc**) create lowercase letters. Use the right area (labeled **123**) for writing numbers, symbols, special characters, and punctuation.

---

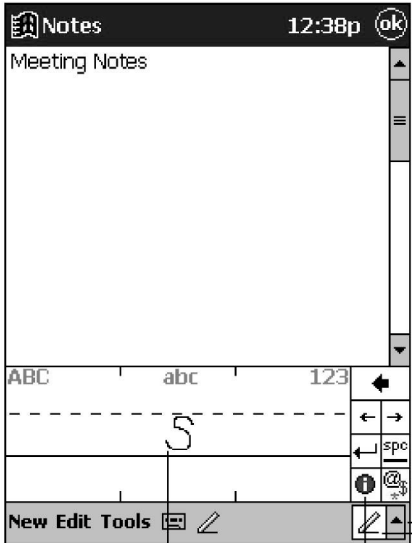

Tap to select an input method or change options.

Tap to show or hide the input panel.

Tap to see how to write letters.

The letter you write is converted to typed text that appears on the screen.

The following chart is a partial display of the characters you can write while in lowercase mode (the dot on each character is the starting point for writing). Remember that even though you write a letter in its lowercase form, the case of the text that is displayed depends on where you write the letter. For example, if you write a lowercase “a” in the **ABC** area, an uppercase “A” is displayed on the screen.

Letter Area

A	a	a			N	n			
B	b	b			O	o	o		
C	C				P	p	p		
D	d	d			Q	q	q		
E	e				R	r	r		
F	f	f			S	s			
G	g	g			T	t	7	7	7
H	h	h			U	u	u		
I	i	i			V	v			
J	J	J			W	w	w		
K	k	k	K	α	X	x	x		
L	l	l	l		Y	y	y		
M	m				Z	z			

space	—
back space	—

Number/Punctuation Area

0	0			)	)			
1	1			+	+			
2	2	2		*	x	∞		
3	3			/				
4	4	4	4	\				
5	5	5	5	?	?	?		
6	6			!	!			
7	7			@	@			
8	8			&	4			
9	9			‘	‘			
>	>			“	“			
·	·			-	-			
(	(							

enter	—
back space	—

For more information on using Character Recognizer and for demos of all characters, tap  on the Character Recognizer Input panel.



# Appendix B

## Migrating data from other devices

### Transferring data from a palm-size or handheld PC

If you are currently using a Windows-powered palm-size or handheld PC, you can transfer data to your HP Jornada Pocket PC. If you have offline folders in Inbox on your palm-size or handheld PC that contain e-mail messages you want to transfer to your Pocket PC, you will have to follow a separate procedure, included below.

#### To transfer data from another Windows-powered device

1. Install Microsoft ActiveSync 3.1 on your desktop PC. For information on installing ActiveSync, see the *Getting Started with Microsoft ActiveSync* booklet.
  2. Synchronize your device with your desktop PC, so that the information on your desktop PC is current.
  3. If you have files on your device that you want to transfer, such as Note Taker notes and recordings, turn file conversion off in ActiveSync options so that the files stay in device format, and use ActiveSync Explorer to copy the files to your desktop PC. For specific instructions, see ActiveSync Help on the desktop PC.
  4. Synchronize your Pocket PC with your desktop PC. This will update your HP Jornada with the current data from your desktop PC.
  5. Reinstall programs. Check with the program vendors to find out if new versions that have been optimized for the Pocket PC are available.
  6. Using ActiveSync Explorer, copy the files you transferred to your desktop PC in step 3 to your Pocket PC.
  7. In ActiveSync, turn file conversion on again.
  8. Enter settings and connection information on the Pocket PC.
-

### To transfer offline folders

1. Connect your palm-size or handheld PC to your desktop PC, and then click **Windows CE Inbox Transfer** on the Microsoft Outlook **Tools** menu.
2. Select **Copy or move selected messages to your desktop computer**, and then click the Browse button.
3. Select the offline folder that contains the messages you want to transfer to your desktop PC, and then click **OK**.
4. Click the Transfer button and select the folder you want to transfer the messages to or click **New Folder** to create a new folder. Click **OK** to transfer the messages. Now you must transfer the messages from your desktop PC to your HP Jornada.
5. In Inbox on your HP Jornada, tap **Tools** and then tap **New Folder** to create a folder for the messages you are going to transfer.
6. In Outlook on your desktop PC, select the messages you want to transfer.
7. Connect your HP Jornada to your desktop PC, and then click **Windows CE Inbox Transfer** on the Outlook **Tools** menu.
8. Select **Copy selected messages to your mobile device**, and then click the Browse button.
9. Select the offline folder on your device that you want to transfer the messages to, and then click **OK**.
10. Click the Transfer button. The selected messages are moved to your HP Jornada.

## Migrating data from Palm devices

### Migrating from Palm III and newer products

Palm V™ and Palm III™ series connected organizers can synchronize data with Microsoft Outlook 97/98. From Microsoft Outlook you can synchronize the data to your HP Jornada using ActiveSync. Use PocketMirror® from Chapura™ (included with the Palm™ Desktop organizer software) to synchronize data between your Palm Computing handheld and Microsoft Outlook.

To use Chapura's PocketMirror conduit, first install the Palm desktop software that is included with your Palm IIIx™ or Palm V organizer. If you choose to synchronize with Microsoft Outlook, the PocketMirror conduit will be installed with the Palm desktop software. For more information, go to the Palm Web site at [www.palm.com](http://www.palm.com).

---



## Migrating from older Palm organizers

If you would like to use PocketMirror to synchronize your PalmPilot or Pilot organizer with Microsoft Outlook, you will need to purchase the commercial version of the software from Chapura, the maker of PocketMirror. Check with Chapura directly.





# Index

## A

ac adapter ..... 2, 12, 34, 115  
 accessories ..... 92  
 Action button ..... 10, 25, 68  
 ActiveSync ..... 2, 7, 29, 30, 36, 41, 95,  
 100, 123  
   installing ..... 30  
   system requirements ..... 30  
 ActiveSync CD-ROM ..... 6, 7, 30, 31,  
 88, 89  
 adding programs ..... 5, 72  
 address book ..... See Contacts  
 alarm ..... 14  
 appointments ..... See Calendar  
 AudibleManager ..... 6  
 AudiblePlayer ..... 6  
 audio files  
   creating ..... 87, 88  
   formats ..... 5, 86  
   packaged content ..... 88  
   playing ..... 86, 88  
   storing on CompactFlash card .... 89  
 AvantGo Channels ..... See channels

## B

backing up ..... 40, 41  
   restoring data ..... 42, 43  
   to a CompactFlash card ..... 41  
   to a desktop PC ..... 41  
   using ActiveSync ..... 40, 41  
   using HP backup ..... 40, 41  
 backlight ..... 14, 62, 104  
 Backlight control panel ..... 62  
 batteries ..... See power  
 brightness ..... See display  
 browser, Web ..... See Pocket Internet  
   Explorer  
 browsing  
   files and folders ..... 27, 39  
   the Web ..... 51, 52

## C

calculator ..... See OmniSolve  
 Calendar 3, 4, 5, 15, 23, 25, 37, 40, 41,  
 43, 75, 76, 77, 81, 82, 104  
 Calendar hot key ..... 15  
 cellular phone ..... See mobile phone  
 channels ..... See also Mobile Favorites  
   AvantGo ..... 52, 53  
   mobile ..... 31, 45, 52, 53  
   synchronizing ..... 53  
   viewing ..... 53  
 Character Recognizer ... 20, 21, 22, 23,  
 84, 119, 121  
 charging ..... See power  
 clock ..... 18  
 Command bar ..... 19  
 CompactFlash card  
   installing ..... 47, 93  
   memory ..... 63, 93  
   modem ..... 46, 93  
   NIC ..... 46  
   Socket Low Power  
     Ethernet card ..... 47  
 CompactFlash card slot ..... 11, 47, 94  
 connecting  
   by cradle ..... 34  
   by infrared ..... 35, 48  
   by LAN ..... 38, 39  
   by mobile phone ..... 48  
   by modem ..... 46  
   by sync cable ..... 33, 34, 35  
   to a desktop PC ..... 33, 34, 35  
   to a network ..... 102  
   to a remote computer ..... 45  
   to an ISP ..... 48  
   to the Internet ..... 45, 48  
   troubleshooting connections ..... 103  
 contacting HP ..... 106  
 Contacts ..... 3-5, 15, 23, 25, 37, 40, 41,  
 43, 75, 77, 78, 81, 82, 104  
 Contacts hot key ..... 15  
 contrast ..... See display

converting files ..... 40  
 cover ..... 10, 16, 113  
 cradle ..... 33  
 customer service See technical support

## D

dc jack ..... 12, 34  
 dial-up connection, disconnecting ..... 19  
 disconnecting dial-up connection ..... 19  
 display  
   brightness ..... 4, 13, 64, 99, 103, 104  
   cleaning ..... 11  
   contrast ..... 4, 13, 64, 99, 103, 104  
   troubleshooting ..... 12, 103  
   turning off ..... 87  
 drawing onscreen ..... 24, 85  
 drivers, installing ..... 93

## E

eBooks ..... 89  
 e-mail  
   attachments ..... 59, 60  
   creating an e-mail service ..... 57  
   deleting messages ..... 56, 59  
   folders ..... 60  
   receiving messages ..... 55, 56, 58  
   sending messages ..... 55, 56, 59  
   sending recordings in ..... 27  
   synchronizing ..... 56  
 EMusic.com ..... 6, 87  
 entering information ..... 20, 84

## F

factory default settings ..... 97  
 Favorites folder ..... 53  
 File Explorer ..... 27, 71, 73, 101  
 files  
   converting ..... 40  
   transferring ..... 39, 40  
 Find feature ..... 27  
 finding information ..... 27

## G

games . See profiles, HP game buttons  
 GSM files ..... 26

## H

hardware buttons ..... 4, 14, 61, 68, 69  
   configuring ..... 68  
 headphone jack ..... 11  
 HP backup ..... 4, 40-43, 97, 100  
 HP Dynamic Voice ..... 26  
   installing ..... 31  
 HP game buttons ..... 4, 19, 68, 69  
 HP home menu ... 4, 13, 15, 17, 18, 64,  
   70, 71  
 HP home menu hot key ..... 15  
 HP hot keys ..... 10, 11, 15, 68  
 HP info exchange ..... 4, 81, 82  
 HP Jornada CD-ROM ..... 2, 6, 7, 87, 88  
 HP security ..... See security  
 HP settings ... 4, 13, 14, 15, 62, 64, 65,  
   99, 103, 104  
 HP task switcher... 4, 17-19, 41-43, 63,  
   64, 96, 99  
 HPC Notes ..... 6

## I

IMAP4 protocol ..... 49, 57, 60, 115  
 Inbox5, 37, 50, 55-60, 75, 77, 123, 124  
   folders ..... 60  
 Inbox synchronization ..... 56  
 information  
   entering ..... 20, 84  
   exchanging ..... 4, 81, 82  
   owner ..... 68  
 infrared modem ..... 48  
 infrared port ..... 11, 81  
 Input panel ..... 20  
 installing programs ..... 5, 72  
 interference, radiated ..... 12  
 Internet  
   Pocket Internet Explorer ..... 51  
   Web browsing ..... 51  
 Internet service provider  
   connecting to ..... 48  
 intranet ..... 3, 45, 51  
 ISP ..... See Internet service provider

## KLM

keyboard ..... See soft keyboard  
 LAN ..... 31, 38, 116  
 mail ..... See e-mail  
 Media Player ..... See Windows Media  
   Player  
 meeting requests ..... 77

memory  
 increasing ..... 63, 73, 90  
 managing ..... 63  
 program ..... 63  
 storage ..... 18, 26, 27, 55, 63,  
 73, 88, 89  
 microphone ..... 20, 25  
 Microsoft ActiveSync... See ActiveSync  
 Microsoft Exchange ..... 55, 56, 75  
 Microsoft Outlook .... 31, 37, 39, 55, 56,  
 75, 100, 124, 125  
 Microsoft Pocket Outlook .... See Inbox,  
 Contacts, Calendar, or Tasks  
 Microsoft Reader ..... 5, 7, 83, 89  
 Mobile Channels ..... See channels  
 Mobile Favorites ..... 31, 37, 53, 54, 55  
 mobile phone ..... 48  
 Mobile Voice ..... 26  
 modem  
 CompactFlash card ..... 46  
 disconnecting ..... 19  
 infrared ..... 48  
 installing ..... 46  
 MP3 files ..... 5, 6, 86  
 music ..... See audio files  
 MusicMatch JukeBox ..... 6, 87

## N

navigating ..... 16  
 Navigation bar ..... 18  
 network ..... See LAN  
 network interface card ..... 46, 47, 49,  
 50, 93, 102, 116  
 New Partnership Wizard ..... 36  
 NIC ..... See network interface card  
 Notes ..... 3, 5, 23, 25, 27, 68, 75,  
 77, 78, 80-82, 104  
 Notification LED ..... 10, 14, 103

## O

OmniSolve ..... 3, 5, 83, 90  
 On/Off button ..... 10, 14, 16, 98-100  
 online Help ..... 2, 7, 8, 50, 83, 90  
 owner information ..... 68

## P

Palm devices  
 migrating data ..... 124  
 Palm devices, migrating data. 124, 125

partnership  
 establishing ..... 36  
 multiple ..... 36  
 New Partnership Wizard ..... 36  
 passwords  
 clearing ..... 67  
 for a network ..... 49, 50, 102  
 for backup files ..... 40  
 for e-mail ..... 49, 57  
 for HP Jornada ..... 4, 66, 67  
 delay ..... 67  
 primary ..... 66, 67  
 reminder ..... 67  
 for notes ..... 6  
 for Pocket Excel workbooks ..... 86  
 for the Internet ..... 49, 50  
 forgetting ..... 67, 97  
 PCM files ..... 26  
 personal information manager ..... 4,  
 37-43, 81, 82, 100, 116  
 PIM See personal information manager  
 Playlist Manager ..... 88  
 Pocket Excel ..... 3, 5, 83, 85, 86, 104  
 templates ..... 85  
 Pocket Internet Explorer ..... 5, 51,  
 52, 104  
 Pocket Outlook ..... 81, 82  
 Pocket Word ..... 3, 5, 23, 83-85, 104  
 POP3 protocol ..... 49, 57, 60, 116  
 pop-up menus ..... 20  
 power ..... 62  
 charging ..... 2, 14, 19, 62  
 conserving ..... 62  
 LED indicators ..... 62  
 low-power warnings ..... 62  
 typical usage ..... 62  
 Power control panel ..... 14, 18, 62, 65  
 profiles  
 games ..... 4, 68, 69  
 settings ..... 64, 65, 99  
 program memory ..... 63  
 programs  
 additional ..... 5  
 assigning to a hardware button ..... 68  
 closing ..... 63  
 HP ..... 4  
 installing ..... 5, 72  
 Microsoft ..... 5  
 quitting ..... 63  
 removing ..... 4-6, 8, 63, 73  
 switching ..... 17  
 third-party ..... 5

**QR**

- quitting programs ..... 63
- radiated interference ..... 12
- recharging ..... See power
- Record button ..... 10, 15, 25, 66, 68
  - disabling ..... 15
- recording
  - formats ..... 26, 31, 85
  - playing ..... 25
  - sending ..... 27
  - voice notes ... 10, 15, 20, 25, 77, 78, 80, 81, 84, 85
- registration ..... 13
- removing programs ..... 4-6, 8, 73
- Reset button ..... 11, 13, 96, 98
- resetting ..... 96
- restoring
  - factory defaults ..... 97
  - from backup ..... 42
  - incremental backups ..... 43
  - using ActiveSync ..... 42
  - using HP backup ..... 43

**S**

- screen protector ..... 11, 92
- scrolling speed ..... 69
- searching ..... 27
- security ..... 66
  - log ..... 67
  - owner information ..... 68
  - passwords ..... 4, 66, 67
- serial connector ..... 2, 10, 33, 34, 38, 39, 92
- settings ..... See HP settings
- Socket Low Power Ethernet card ..... 47
- soft keyboard ..... 20, 21
- software drivers ..... 93
- Software Product
  - License Agreement ..... 111
- speaker ..... 19, 65
  - mute ..... 64
  - volume ..... 4, 64, 65
- Start menu ..... 18, 71
- status icons ..... 19
- stopping programs ..... 63
- storage memory ..... 18, 26, 27, 55, 63, 73, 88, 89
- stylus ..... 92
  - calibrating ..... 16
  - using ..... 16
- switching programs ..... 17

- switching views ..... 15
- sync cable ..... 33
- synchronization .. 7, 36, 37, 55, 56, 116
  - channels ..... 53
  - conflicts ..... 38
  - Inbox ..... 56
  - remote ..... 38, 39
- system requirements, ActiveSync .... 30

**T**

- Tasks ..... 3-5, 15, 20, 23, 25, 37, 40, 41, 43, 75, 79, 81, 82, 104
- Tasks hot key ..... 15, 87
- technical support ..... 3, 13, 105
- temperature ..... 12
- templates
  - Pocket Excel ..... 85
  - Pocket Word ..... 84
- Today screen ..... 4, 8, 17-19, 41-43, 62, 69, 96
- touch screen ..... 10
  - aligning ..... 16, 100
  - cleaning ..... 11
- transferring
  - data from handheld PCs ..... 123
  - files ..... 39, 40
  - offline folders ..... 124
  - recordings ..... 31
- troubleshooting
  - basic problems ..... 98
  - connections ..... 8, 103
  - display ..... 12, 103
  - infrared ..... 102
  - network connections ..... 102
  - remote connections ..... 101

**VW**

- voice notes ..... See recording
- warranty
  - hardware ..... 109
  - software ..... 111
- WAV files ..... 5, 86
- Web ..... 51, 52
- Welcome Wizard ..... 2, 9, 13, 98
- Windows Media Manager ..... 7, 87-89
- Windows Media Player ..... 5, 83, 86, 87
- WMA files ..... 5, 86
- writing onscreen ..... 22, 23, 84, 119
- WWW ..... See Web